

External Gear Pumps Series N

RE 10 091/02.12
Replaces:
RE 10 091/11 .10

AZPN-...

Fixed pumps
 $V = 20...36 \text{ cm}^3/\text{rev}$

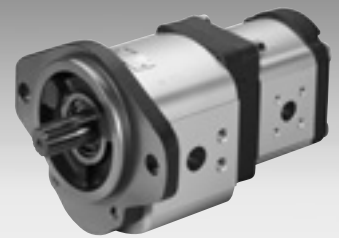

Overview of contents

Contents	Page
General	2
Product overview	3
Ordering code single pumps	4
Ordering code multiple pumps	5
Drive shaft	6
Front cover	6
Line ports	7
Gear pumps with integral valves	8
Design calculations for pumps	8
Performance charts	9
Noise charts	11
Specifications	12
Drive arrangements	13
Multiple gear pumps	15
Dimensions	16
Fittings	21
Service parts	22
Notes for commissioning	23
Ordering-No.	23

Features

- Nominal pressure 250 bar
- Slide bearings for heavy duty applications
- Drive shafts to ISO or SAE
- Combination of several pumps possible
- Line ports: connection flanges
- Consistent high quality thru mass production
- Numerous configuration variants available

General

Rexroth external gear pumps are available as standard gear pumps in the 4 series of B, F, N and G and as SILENCE gear pumps in the series of S, T and U, in which the displacements are graded by different gear widths. Further configuration variants are given by different flanges, shafts, valve arrangements and multiple pump combinations.

Construction

The external gear pump consists essentially of a pair of gears supported in bearing bushings or bearing, dependent on the series, and the case with a front and rear cover. The drive shaft protrudes from the front cover where it is sealed by the shaft seal ring. The bearing forces are absorbed by special bearing bushings with sufficient elasticity to produce surface contact instead of line contact. They also ensure excellent resistance to galling – especially at low speed. The gears have 12 teeth. This keeps both flow pulsation and noise emission to a minimum.

The internal sealing is achieved by forces which are proportional to delivery pressure. This ensures optimum efficiency. The bearings provide the seal at the ends of the gaps between the teeth which carry the pressurized oil. The sealing zone between the gear teeth and the bearings is controlled by the admission of operating pressure to the rear of the bearing bushings. Special seals form the boundary of the zone. The radial clearance at the tips of the gear teeth is sealed by internal forces pushing them against the case.

Gear pump axial compensation

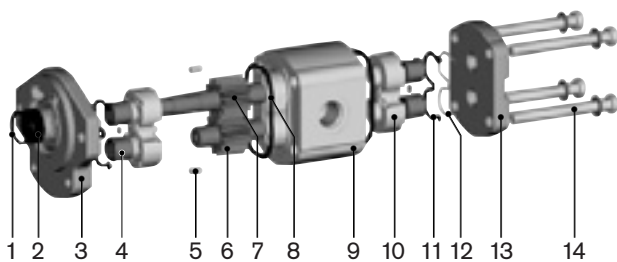
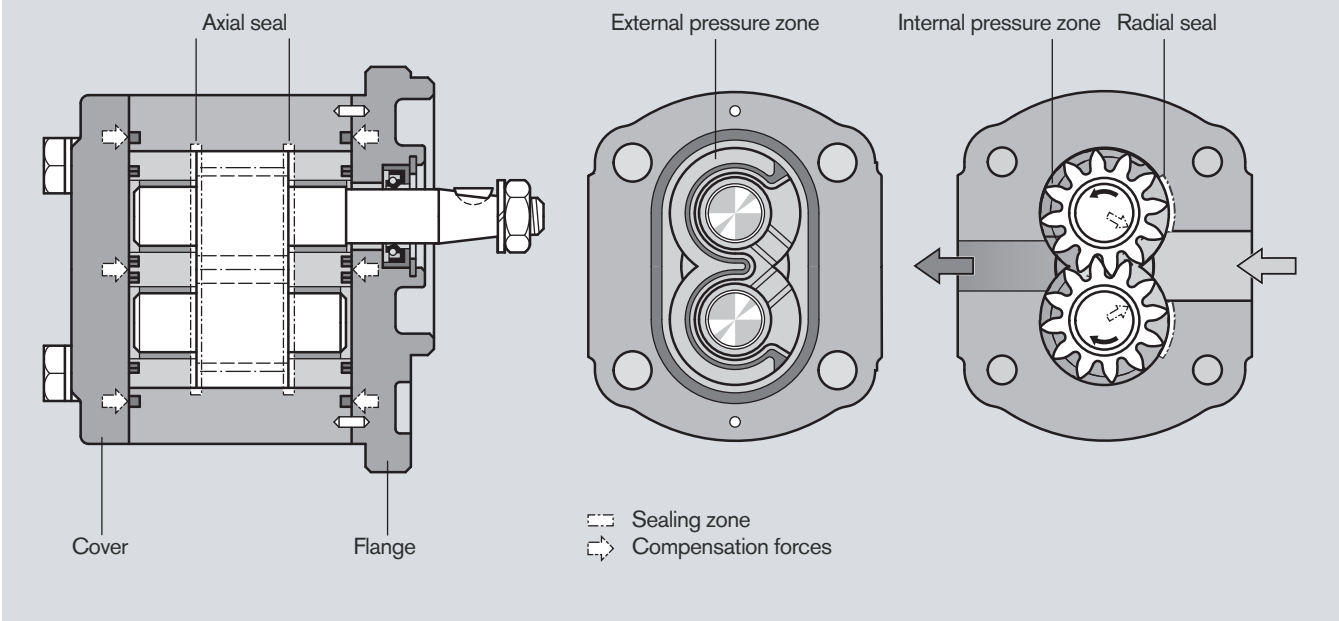

- | | |
|---------------------|--------------------|
| 1 Retaining ring | 8 Case seal |
| 2 Shaft seal ring | 9 Pump case |
| 3 Front cover | 10 Bearing |
| 4 Slide bearing | 11 Axial zone seal |
| 5 Centering pin | 12 Support |
| 6 Gear | 13 End cover |
| 7 Gear (frictional) | 14 Fixing screws |

Overview of "Series N" standard types

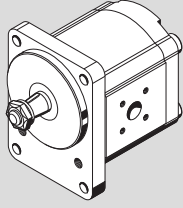
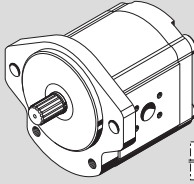
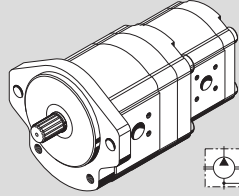
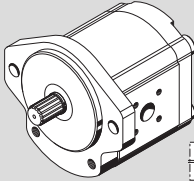
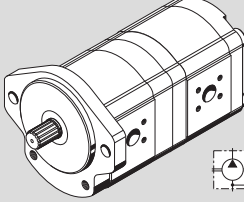
Version	Page	Version	Page	Version	Page
	16		18		20
	17		19		

The AZ configurator at www.boschrexroth.com/azconfigurator

The AZ configurator assists you to configure your individual external gear unit easily and user-friendly. You only need to specify your requirements: From the displacement, direction of rotation, drive shaft, connection flange right up to the required rear cover. You immediately receive a project drawing (PDF format) if a configuration already exists. You receive the price of the configured external gear unit upon request.



The AZ configurator assists you to configure your individual external gear unit easily and user-friendly – all data needed for project planning are acquired thru menu guidance.

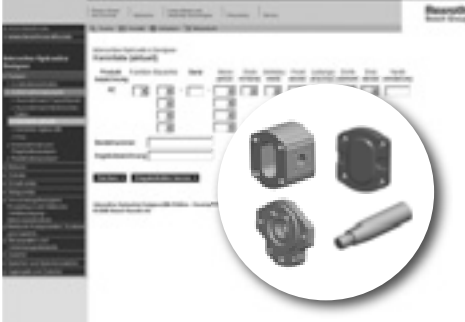









Selection is made either on an ordering code or your technical requirements. This means that you can search for external gear units that have already been configured, or you specify the configuration variant of the external gear unit based upon the operating parameters you require.



If the external gear unit you selected has been released you will receive the part number, ordering code and a detailed installation drawing. If your special configuration is not available please send your specification to Rexroth. One of our employees will then contact you.

Ordering code

External gear units, single pumps, standard

























AZ	P	N	-	x	x	-	020	R	C	B	20	M	B	18009	S xxxx																								
<table border="1"> <tr> <td>Function</td> <td rowspan="2">Special design *)</td> </tr> <tr> <td>P = Pump</td> </tr> <tr> <td>Series</td> <td rowspan="2"></td> </tr> <tr> <td>1 = Case width 92 mm</td> </tr> <tr> <td>2 = Case width 110 mm</td> </tr> <tr> <td>Version</td> <td rowspan="2"></td> </tr> <tr> <td>1 = Phosphatized, pinned</td> </tr> <tr> <td>2 = Chromatized, pinned</td> </tr> <tr> <td>Size N</td> <td rowspan="6"></td> </tr> <tr> <td>020 = 20.0 cm³/rev</td> </tr> <tr> <td>022 = 22.5 cm³/rev</td> </tr> <tr> <td>025 = 25.0 cm³/rev</td> </tr> <tr> <td>028 = 28.0 cm³/rev</td> </tr> <tr> <td>032 = 32.0 cm³/rev</td> </tr> <tr> <td>036 = 36.0 cm³/rev</td> </tr> <tr> <td>Direction of rotation</td> <td rowspan="2"></td> </tr> <tr> <td>R = Clockwise</td> </tr> <tr> <td>L = Counterclockwise</td> </tr> </table>															Function	Special design *)	P = Pump	Series		1 = Case width 92 mm	2 = Case width 110 mm	Version		1 = Phosphatized, pinned	2 = Chromatized, pinned	Size N		020 = 20.0 cm ³ /rev	022 = 22.5 cm ³ /rev	025 = 25.0 cm ³ /rev	028 = 28.0 cm ³ /rev	032 = 32.0 cm ³ /rev	036 = 36.0 cm ³ /rev	Direction of rotation		R = Clockwise	L = Counterclockwise	<p>*) Some of the special designs shown on pages 16–21 are not covered in the illustration of the ordering code.</p>	
Function	Special design *)																																						
P = Pump																																							
Series																																							
1 = Case width 92 mm																																							
2 = Case width 110 mm																																							
Version																																							
1 = Phosphatized, pinned																																							
2 = Chromatized, pinned																																							
Size N																																							
020 = 20.0 cm ³ /rev																																							
022 = 22.5 cm ³ /rev																																							
025 = 25.0 cm ³ /rev																																							
028 = 28.0 cm ³ /rev																																							
032 = 32.0 cm ³ /rev																																							
036 = 36.0 cm ³ /rev																																							
Direction of rotation																																							
R = Clockwise																																							
L = Counterclockwise																																							
<table border="1"> <tr> <td>Valve adjustment</td> <td rowspan="3"></td> </tr> <tr> <td>200 xx = PRV 200 bar</td> </tr> <tr> <td>xxx 11 = FCV 11 l/min</td> </tr> <tr> <td>18009 = PRV + FCV</td> <td rowspan="2"></td> </tr> <tr> <td>180 bar, 9 l/min</td> </tr> <tr> <td>Rear cover</td> <td rowspan="5"></td> </tr> <tr> <td>B = Standard</td> </tr> <tr> <td>D = PRV residual flow internal</td> </tr> <tr> <td>E = FCV residual flow external</td> </tr> <tr> <td>S = FCV residual flow internal</td> </tr> <tr> <td>V = PRV + FCV</td> </tr> <tr> <td>Seals</td> <td rowspan="2"></td> </tr> <tr> <td>M = NBR</td> </tr> <tr> <td>K = NBR, SSR in FKM</td> </tr> </table>															Valve adjustment		200 xx = PRV 200 bar	xxx 11 = FCV 11 l/min	18009 = PRV + FCV		180 bar, 9 l/min	Rear cover		B = Standard	D = PRV residual flow internal	E = FCV residual flow external	S = FCV residual flow internal	V = PRV + FCV	Seals		M = NBR	K = NBR, SSR in FKM							
Valve adjustment																																							
200 xx = PRV 200 bar																																							
xxx 11 = FCV 11 l/min																																							
18009 = PRV + FCV																																							
180 bar, 9 l/min																																							
Rear cover																																							
B = Standard																																							
D = PRV residual flow internal																																							
E = FCV residual flow external																																							
S = FCV residual flow internal																																							
V = PRV + FCV																																							
Seals																																							
M = NBR																																							
K = NBR, SSR in FKM																																							
Drive shafts							Front cover				Line ports																												
Suitable front cover																																							
C	Tapered key shaft 1 : 5		B	B	Square flange Centering Ø 100 mm		07	Square flange SAE Thread, metric																															
N	Dihedral claw		M	C	SAE J 744 101-2 B 2-bolt flange Ø 101.6 mm		20	Rectangular flange																															
D	Splined shaft SAE J 744 22-4 13T		C	M	2-bolt mounting Centering Ø 52 mm with seal ring																																		
P	Splined shaft SAE J 744 19-4 11T		C																																				

Not all variants can be selected by using ordering code!

Please select the required pump by using the selection tables (standard types) or after consultation with Bosch Rexroth! Special options are possible upon request.

Ordering code

External gear units, multiple pumps, standard

AZ	P	NNFF	-	x	x	-	032/022/016/005	R	C	B	20	20	20	20	K	B
Function P = Pump Series B = 1.0... 7.1 cm ³ /rev S = 4.0...28.0 cm ³ /rev F = 4.0...28.0 cm ³ /rev N = 20.0...36.0 cm ³ /rev G = 22.5...56.0 cm ³ /rev Series, relates to pump section 1 1 = Case width 92 mm 2 = Case width 110 mm Version, relates to pump section 1 1 = Phosphatized, pinned 2 = Chromatized, pinned Size corresponding to each series Direction of rotation R = Clockwise L = Counterclockwise							Rear cover relates to last pump section B = Standard Seals M = NBR P = FKM K = NBR, SSR in FKM Shaft seal relate to pump section 1									
Drive shafts relates to pump part 1 Series B: H Tapered key shaft 1:8  O Suitable front cover O				Front cover relates to pump part 1 O Square flange Centering Ø 25.38 mm				Line ports every pump parts 02 Thread, metric DIN 3852 T1 								
Series F, S: C Tapered key shaft 1:5  B				B Square flange Centering Ø 80 mm 				20 Rectangular flange 								
H Tapered key shaft 1:8  O				O Square flange Centering Ø 36.47 mm 												
R Splined shaft SAE J 744 16-4 9T  R				R SAE J 744 82-2 A Centering Ø 82.55 mm 2-bolt mounting 												
Series N, T: C Tapered key shaft 1:5  B				B Square flange Centering Ø 100 mm 				07 Square flange SAE Thread, metric 								
D Splined shaft SAE J 744 22-4 13T  C				C SAE J 744 101-2 B Centering Ø 101.6 mm 2-bolt mounting 				20 Rectangular flange 								
N Dihedral claw  M				M Centering Ø 52 mm with seal ring 												
Series G, U: C Tapered key shaft 1:5  B				B Square flange Centering Ø 105 mm 				07 Square flange SAE Thread, metric 								
D Splined shaft SAE J 744 22-4 13T  C				C SAE J 744 101-2 B Centering Ø 101.6 mm 2-bolt mounting 				20 Rectangular flange 								
H Tapered key shaft 1:8  O				O Square flange Centering Ø 50.78 mm 												

Not all variants can be selected by using ordering code!

Please select the required pump by using the selection tables (standard types) or after consultation with Bosch Rexroth!

Special options are possible upon request.

Drive shafts

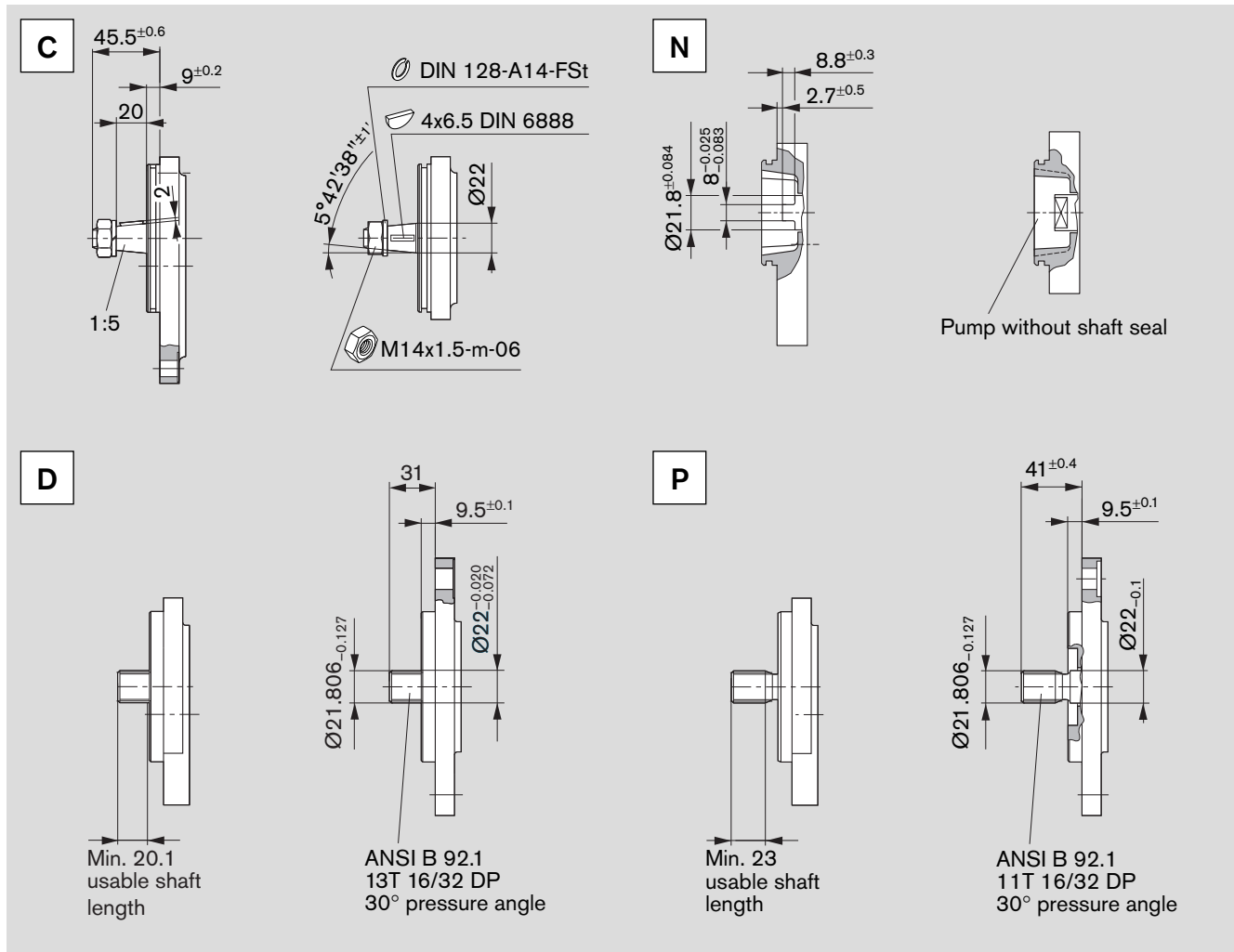

Front cover

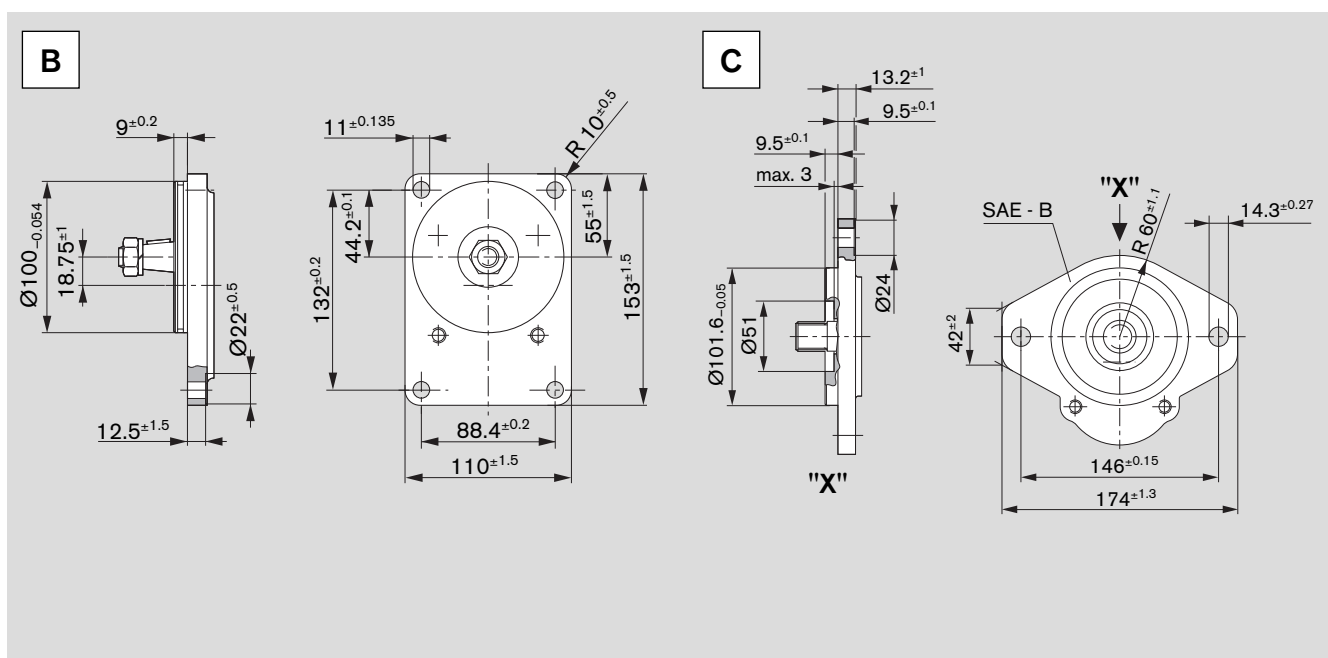

Front cover (continued)

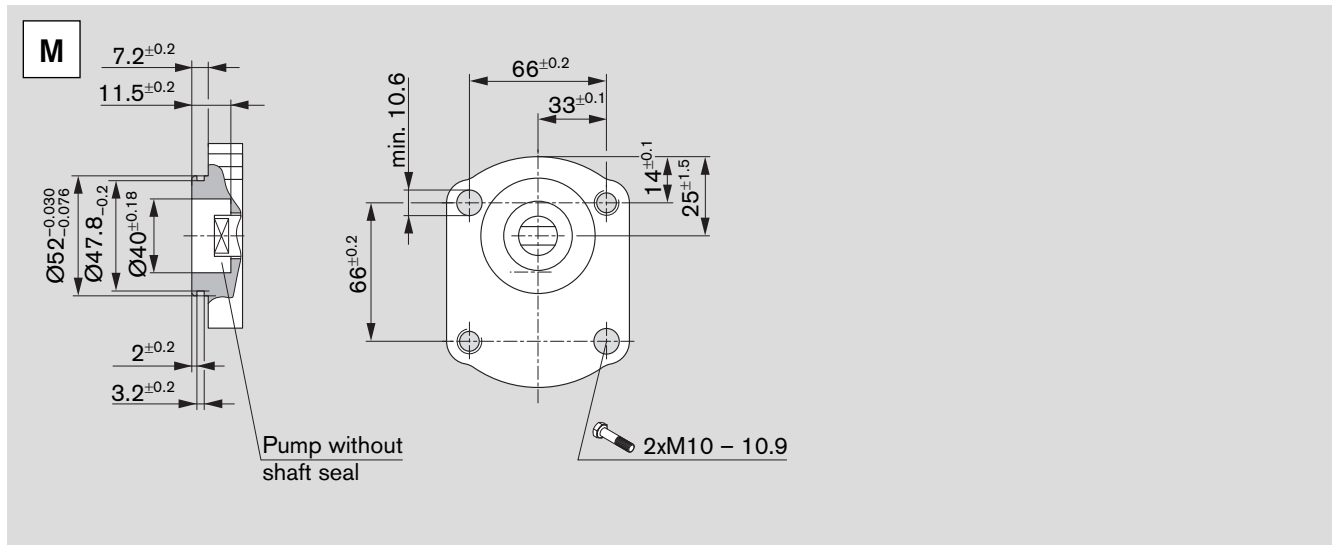

Line ports

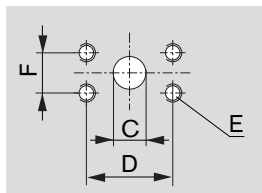

07

Square flange SAE, thread, metric

Ordering code	Size	Pressure side				Suction side			
		C	D	E	F	C	D	E	F
07	20 cm ³	18	47.6	M10 depth 14	22.2	18	47.6	M10 depth 14	22.2
	26.2				26				52.4

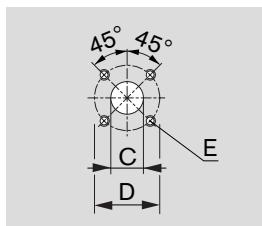

20

Rectangular flange

Ordering code	Size	Pressure side			Suction side		
		C	D	E	C	D	E
20	20...36 cm ³	18	55	M8 depth 13	26	55	M8 depth 13

Gear pumps with integral valves

In order to reduce external pipework it is possible to incorporate a flow-control valve or pressure-relief valve in the cover of the gear pump. A typical application of this is in the supply of hydraulic oil in power steering systems. The pump delivers a constant flow irrespective of the speed at which it is driven. The excess flow is either returned internally to the suction port or distributed externally to other items of equipment.

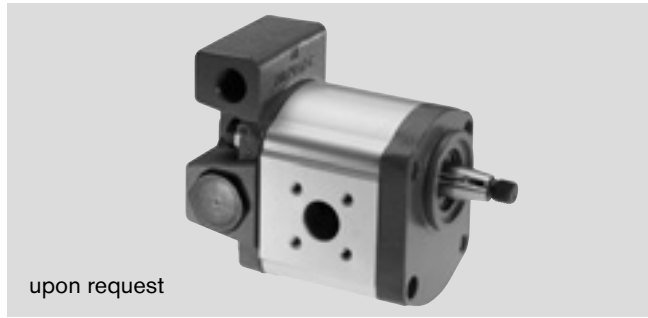

upon request

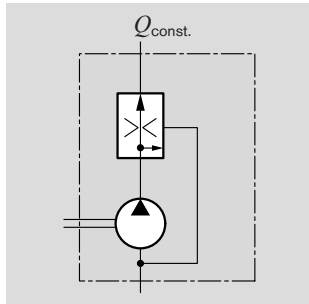

3-way flow-control valve.
Excess flow returned to suction line
 $Q_{const.} = 2...30 \text{ l/min}$

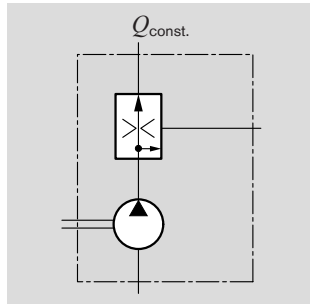

3-way flow-control valve.
Excess flow distributed externally; loadable
 $Q_{const.} = 2...30 \text{ l/min}$

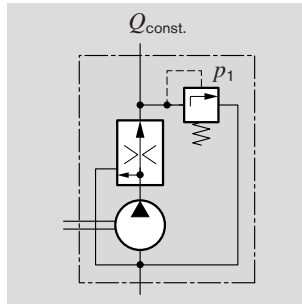

3-way flow-control valve with pressure-relief valve.
Excess flow returned to suction line
 $Q_{const.} = 2...30 \text{ l/min}$
 $p_1 = 100...180 \text{ bar}$

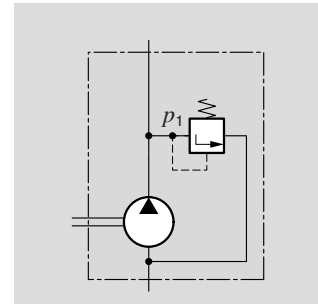

Pressure-relief valve.
Discharge returned to suction line
 $p_1 = 5...250 \text{ bar}$

Ordering code

S	xxx17
---	-------

E	xxx12
---	-------

V	15011
---	-------

D	180xx
---	-------

Design calculations for pumps

The design calculations for pumps are based on the following parameters:

V [cm^3/rev]	Displacement
Q [l/min]	Delivery
p [bar]	Pressure
M [Nm]	Drive torque
n [rev/min]	Drive speed
P [kW]	Drive power

It is also necessary to allow for different efficiencies such as:

η_v	Volumetric efficiency
η_{hm}	Hydraulic-mechanical efficiency
η_t	Overall efficiency

The following formulas describe the various relationships.

They include correction factors for adapting the parameters to the usual units encountered in practice.

Caution: Diagrams providing approximate selection data will be found on subsequent pages.

$$Q = V \cdot n \cdot \eta_v \cdot 10^{-5}$$

$$p = \frac{M \cdot \eta_{hm}}{1.59 \cdot V}$$

$$P = \frac{p \cdot Q}{6 \cdot \eta_t}$$

$$V = \frac{Q}{n \cdot \eta_v} \cdot 10^5$$

$$V = \frac{M \cdot \eta_{hm}}{159 \cdot p}$$

$$Q = \frac{6 \cdot P \cdot \eta_t}{p}$$

$$n = \frac{Q}{V \cdot \eta_v} \cdot 10^5$$

$$M = \frac{1.59 \cdot V \cdot p}{\eta_{hm}}$$

$$p = \frac{6 \cdot P \cdot \eta_t}{Q}$$

[%]

n	η_v	Q	V [cm^3/rev]	Q [l/min]	p [bar]
M	η_{hm}	p	n [rev/min]	P [kW]	M [Nm]
P	η_t	$P \cdot Q$			

Caution: η [%] e.g. 95 [%]

Performance charts

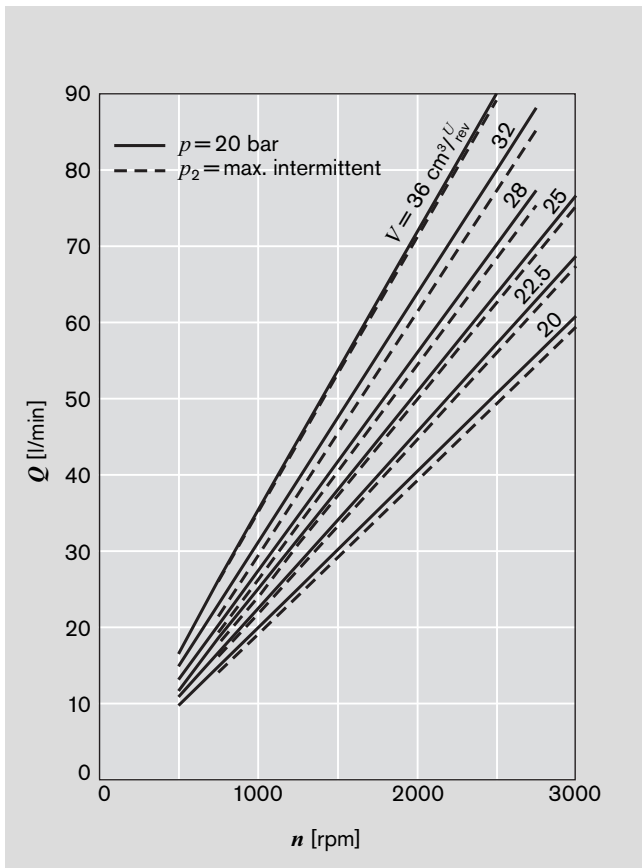

$\nu = 35 \text{ mm}^2/\text{s}, \vartheta = 50^\circ\text{C}$

$Q = f(n, V)$ incl. η_v
 $P = f(n, p)$ — incl. η_t
 $M = f(n, p)$ - - - incl. η_{hm}

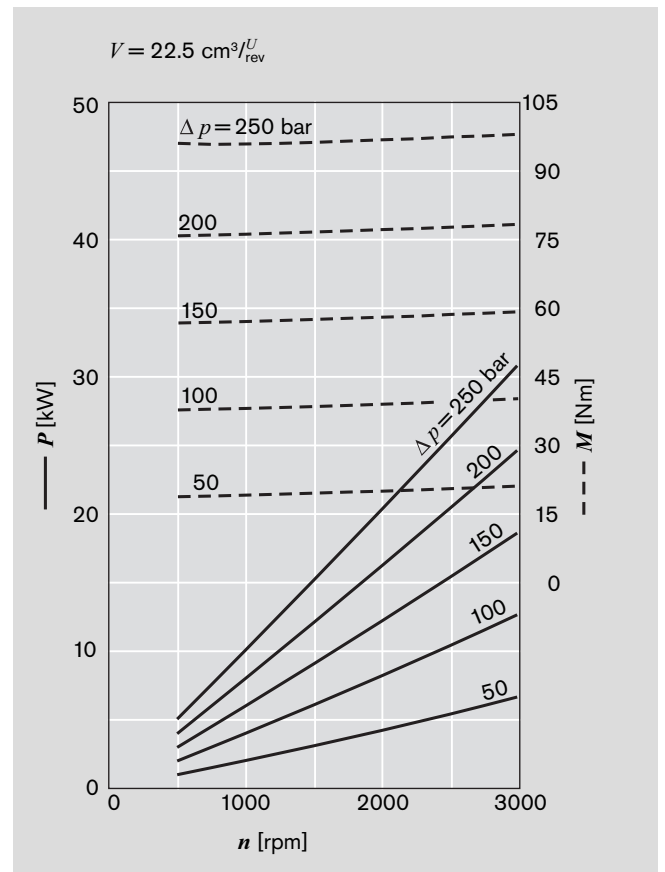
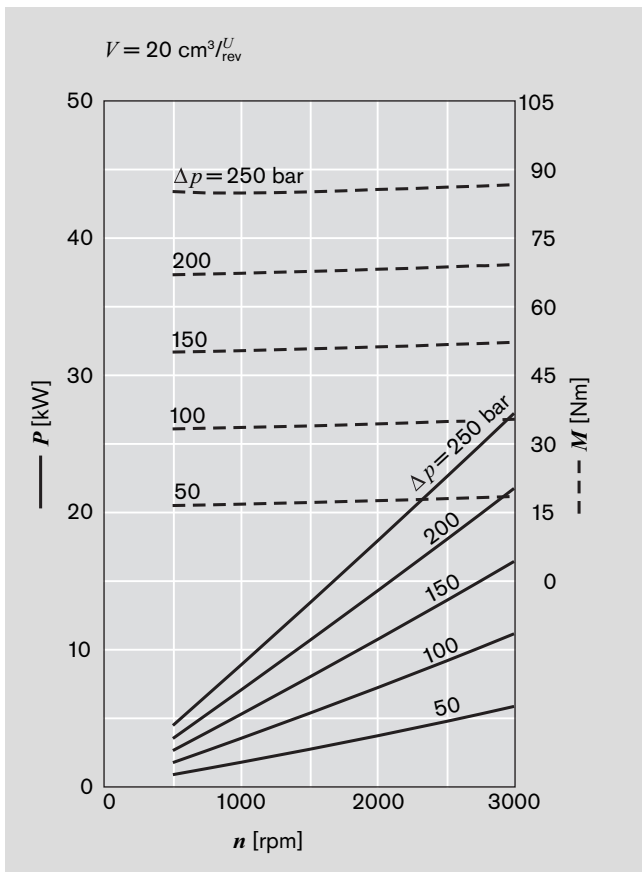

Performance charts (continued)

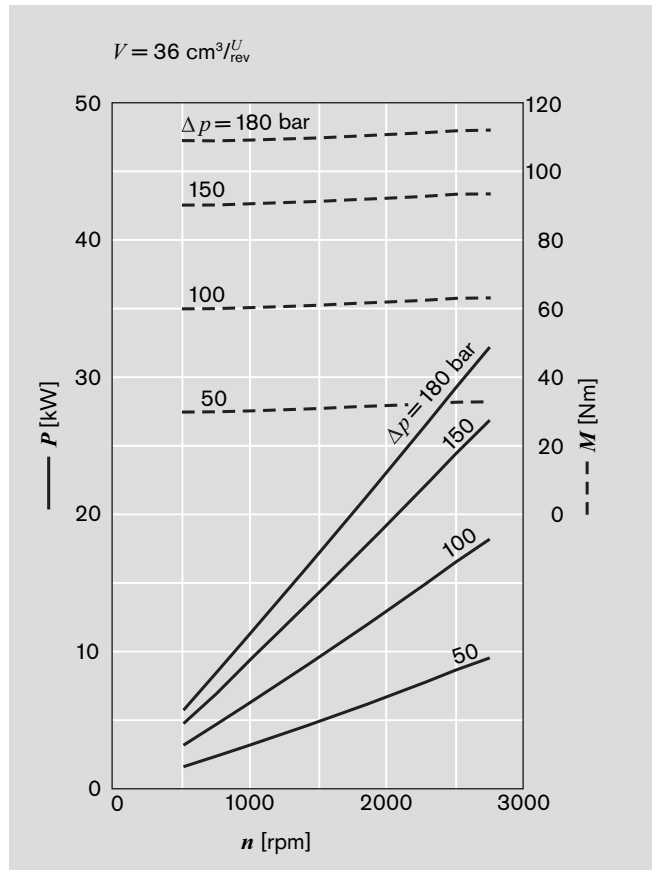
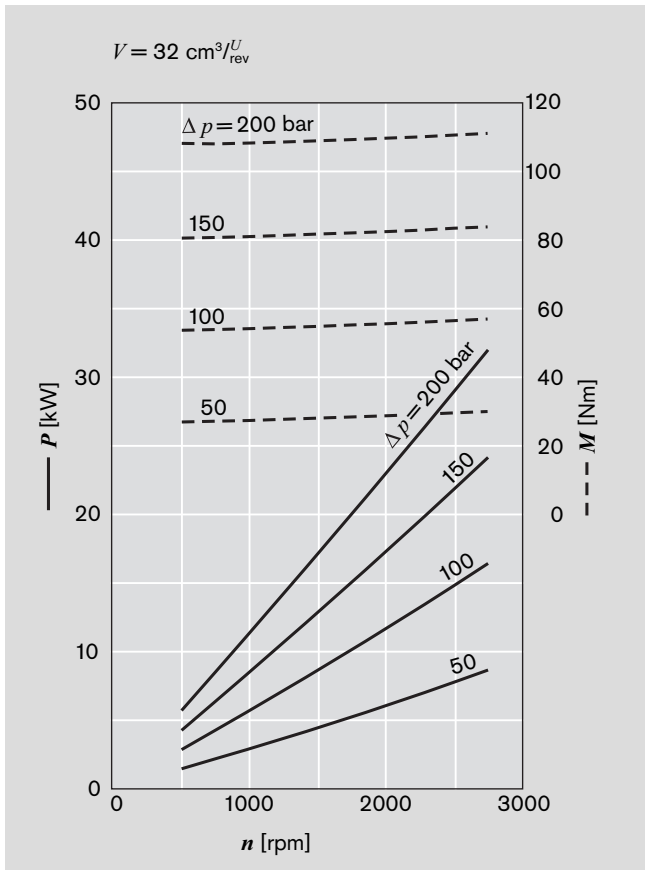
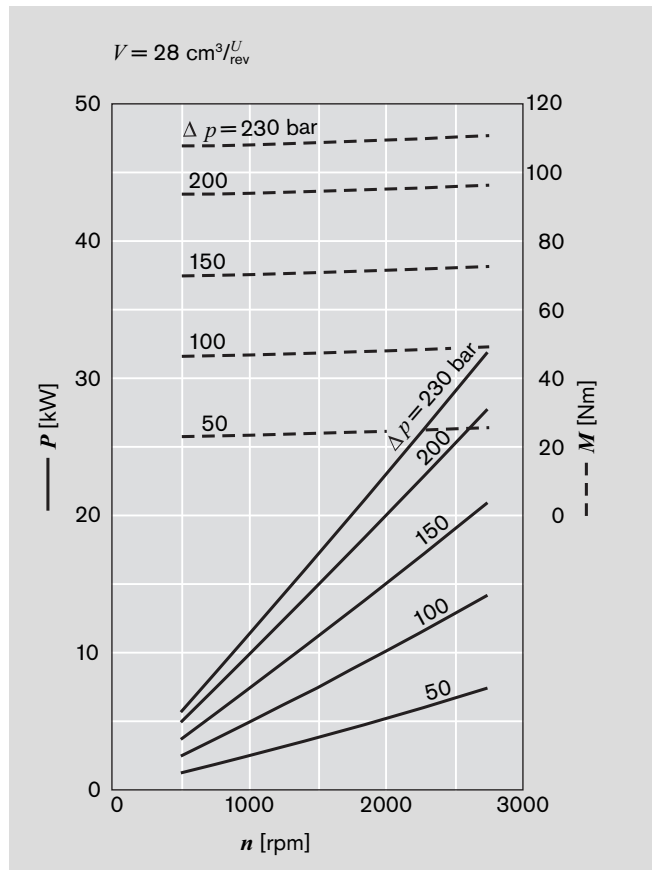
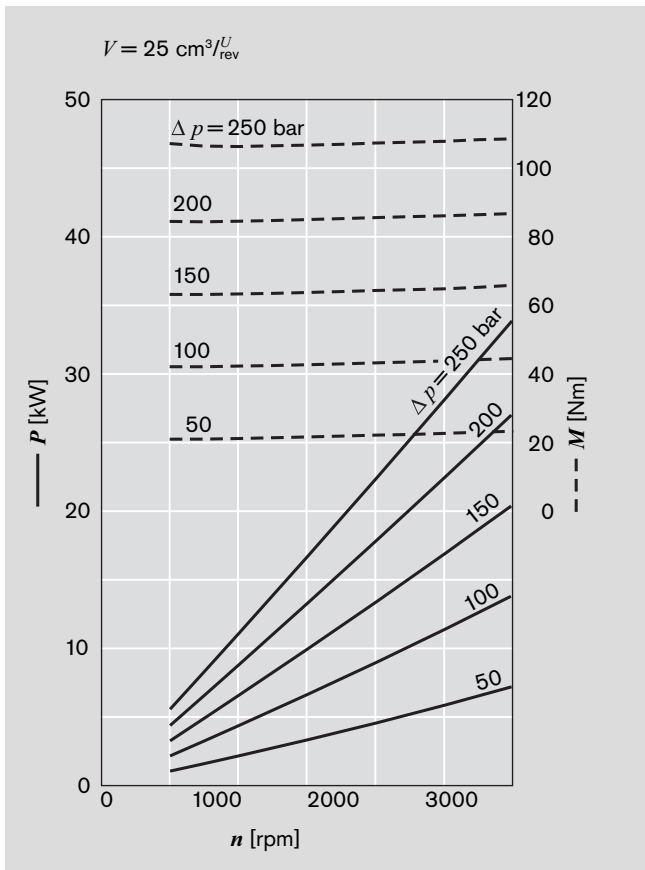

Noise charts

Noise level dependent on rotational speed, pressure range between 10 bar and pressure value p_2 (see page 12/13 Specifications table).

Oil data: $\nu = 32 \text{ mm}^2/\text{s}$, $\vartheta = 50^\circ\text{C}$.

Sound pressure level calculated from noise measurements made in the sound absorbent measuring room compliant with DIN 45635, Part 26.

Spacing between measuring sensor – pump: 1 m.

These are typical characteristic values for the respective model. They describe the airborne sound emitted solely by the pump. Environmental influences (installation site, piping, further system components) are not taken into consideration. Each value applies for a single pump.

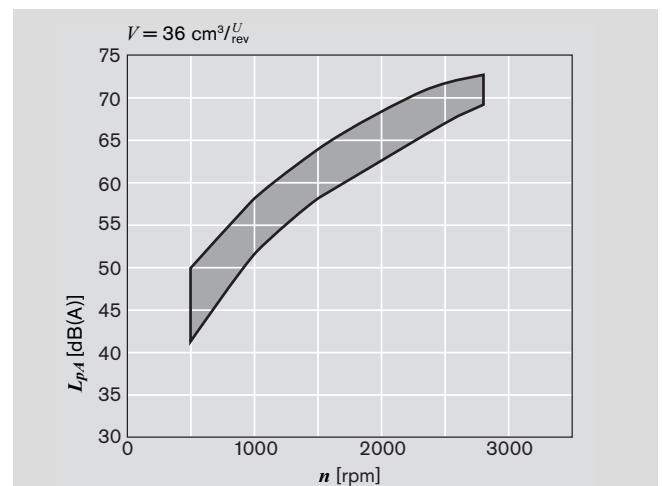
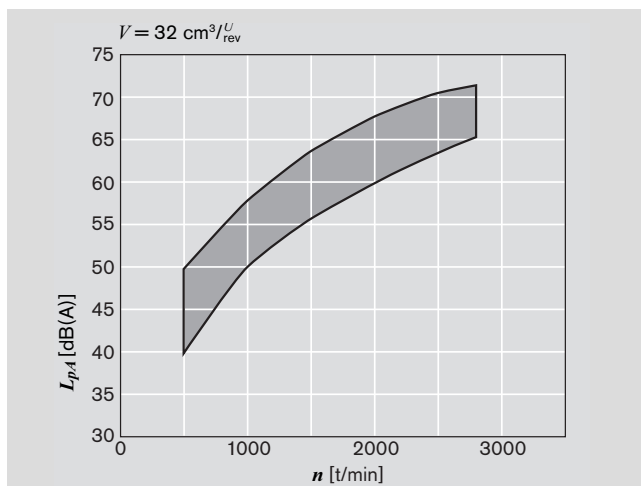
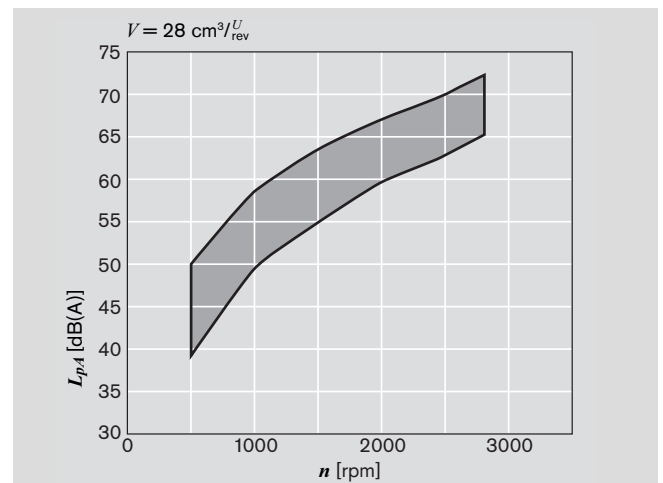
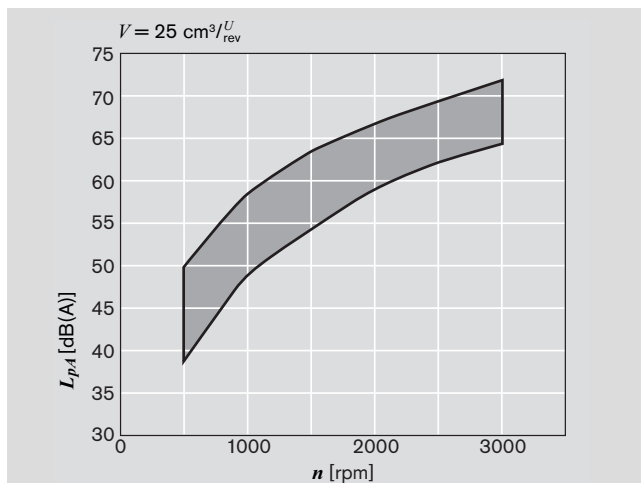
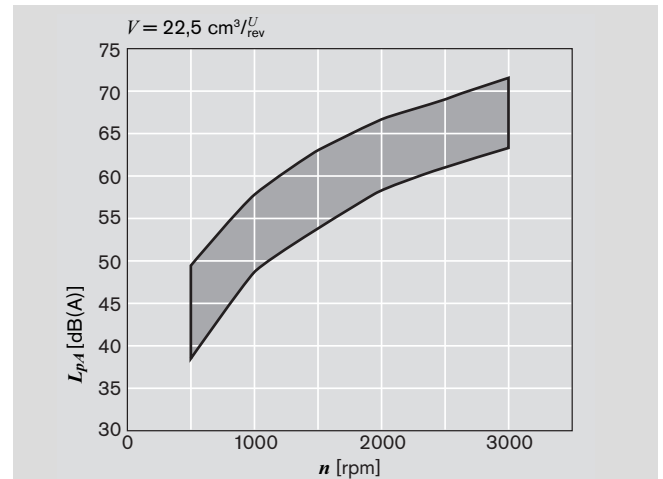
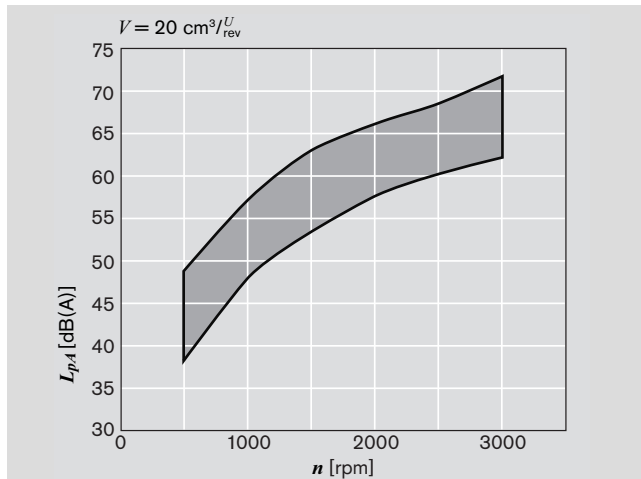

Specifications

General	
Construction	External gear pump
Mounting	Flange or through-bolting with spigot
Line ports	Flange
Direction of rotation (looking on shaft)	Clockwise or counterclockwise, the pump may only be driven in the direction indicated
Installation position	Any
Load on shaft	Radial and axial forces after consulting
Ambient temperature range	-30°C...+80°C or max. 110°C with FKM seals
Hydraulic fluid	- Mineral oil compliant with DIN 51 524, 1-3, however under higher load at least HLP compliant with DIN 51 524 Part 2 recommended. - Comply with RE 90220 - Further operating fluids possible after consultation
Viscosity	12...800 mm ² /s permitted range 20...100 mm ² /s recommended range ...2000 mm ² /s range permitted for starting
Hydraulic fluid temperature range	max. +80°C with NBR seals *) max. +110°C with FKM seals **)
Filtration ***)	At least cleanliness level 20/18/15 compliant with ISO 4406 (1999)

*) NBR = Perbunan®
 **) FKM = Viton®
 ***) During the application of hydraulic systems or devices with critical counter-reaction, such as steering and counterbalance valves, the type of filtration selected must be adapted to the sensitivity of these devices.

Safety requirements pertaining to the whole systems are to be observed.

In the case of applications with high numbers of load cycles please consulting.

Definition of direction of rotation

Always look on the drive shaft.

Caution: Dimensions drawings always show clockwise-rotation pumps. On counter-clockwise-rotation pumps the positions of the drive shaft and the suction and pressure ports are different.

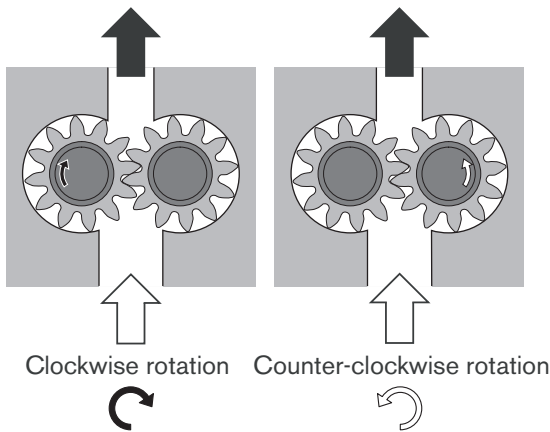

Definitions of pressures

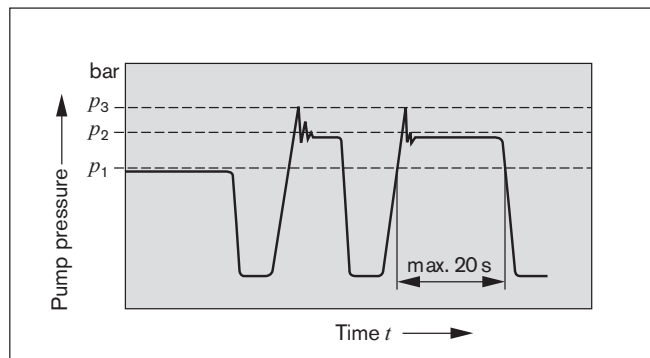

p_1 max. continuous pressure
 p_2 max. intermittent pressure
 p_3 max. peak pressure

AZPN-1x

Displacement	V	cm ³ /rev	20	22.5	25	28	32	36
Suction pressure	p_e	0.7...3 (absolute), with tandem pumps $p_e (p_2) = \max. 0.5 p_e (p_1)$						
Max. continuous pressure	p_1	bar	230	230	230	210	180	160
Max. intermittent pressure	p_2		250	250	250	230	200	180
Max. peak pressure	p_3		270	270	270	250	220	200
Min. rotational speed	< 100	rpm	500	500	500	500	500	500
at bar	12 mm ² /s		600	600	600	600	600	600
	180... p_2		800	800	800	800	800	800
	25 mm ² /s		500	500	500	400	400	400
	p_2		3000	3000	3000	2800	2800	2800
Max. rotational speed at	p_2							

AZPN-2x (only upon request)

Displacement	V	cm ³ /rev	20	22.5	25	28	32	36
Suction pressure	p_e	bar	0.7...3 (absolute), with tandem pumps $p_e(p_2) = \max. 0.5 p_e(p_1)$					
Max. continuous pressure	p_1		250	250	250	230	210	180
Max. intermittent pressure	p_2		280	280	280	260	240	210
Max. peak pressure	p_3		300	300	300	280	260	230
Min. rotational speed	< 100	rpm	500	500	500	500	500	500
at bar	12 mm ² /s		600	600	600	600	600	600
	100...180		800	800	800	800	800	800
	180... p_2		500	500	500	500	500	500
	25 mm ² /s		3000	3000	3000	2800	2800	2800
Max. rotational speed at	p_2							

Drive arrangements

1. Flexible couplings

The coupling must not transfer any radial or axial forces to the pump.

The maximum radial runout of shaft spigot is 0.2 mm.

Refer to the fitting instructions provided by the coupling manufacturer for details of the maximum permitted shaft misalignment.

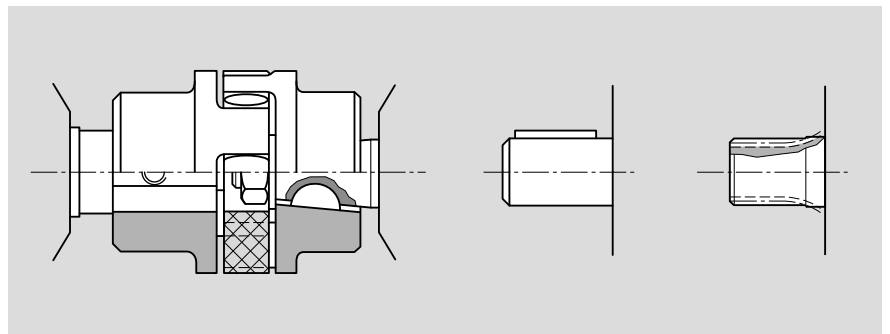

2. Coupling sleeve

Used on shafts with DIN or SAE splining. Caution: There must be no radial or axial forces exerted on the pump shaft or coupling sleeve. The coupling sleeve must be free to move axially. The distance between the pump shaft and drive shaft must be 2⁺¹. Oil-bath or oil-mist lubrications is necessary.

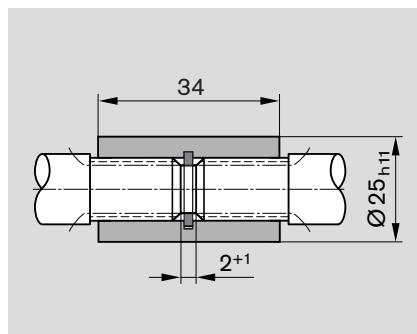

Splined shaft profile	Ordering code	M_{max} [Nm]
SAE-B 13 teeth	D	300
SAE-C 11 teeth	P	n. n.

3. Drive shaft with tang

For the close-coupling of the pumps to electric motor or internal-combustion engine, gear, etc. The pump shaft has a special tang and driver © (not included in supply).

There is no shaft sealing.

The recommended arrangements and dimensions for the drive end and sealing are as follows.

Ⓐ Drive shaft

Case-hardening steel DIN 17 210
 e.g. 20 MnCrS 5
 case-hardened 1.0 deep; HRA 83±2
 Surface for sealing ring
 ground without rifling $R_t \leq 4\mu\text{m}$

Ⓑ Radial shaft seal ring

Rubber-covered seal (see DIN 3760, Type AS, or double-lipped ring).
 Cut 15° chamfer or fit shaft seal ring with protection sleeve.

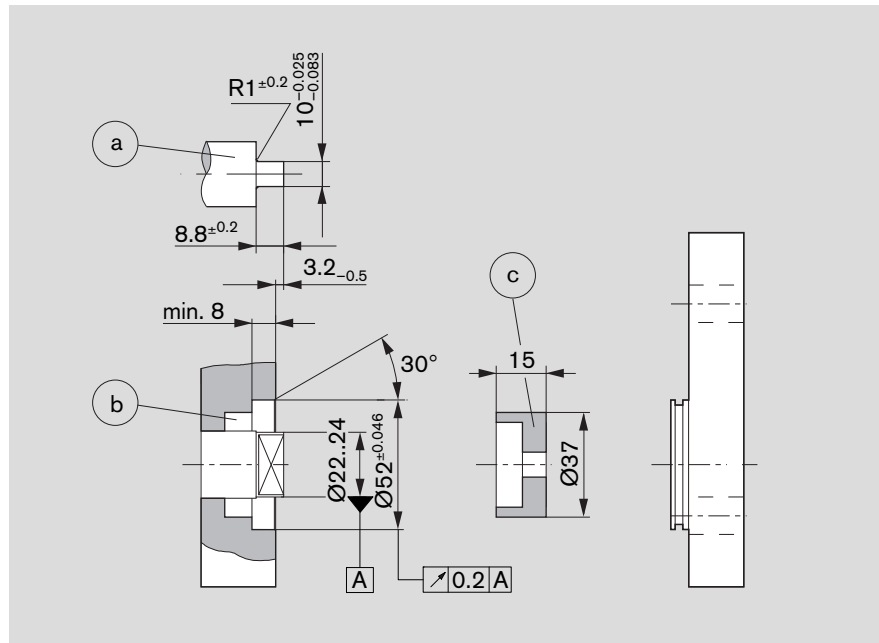

M_{max} [Nm]	V [cm ³ /rev]	p_{max} [bar]
95	20	270
	22.5	240
	25	220
	28	190
	32	170
	36	150

4. V-belts and straight gearwheels or helical toothed gear drives without outboard bearing

When proposing to use V-belt or gear drive, please submit details of the application for our comments (especially dimensions a , d_m , d_w and angle α).
 For helical toothed gear drives, details of the helix angle β are also required.

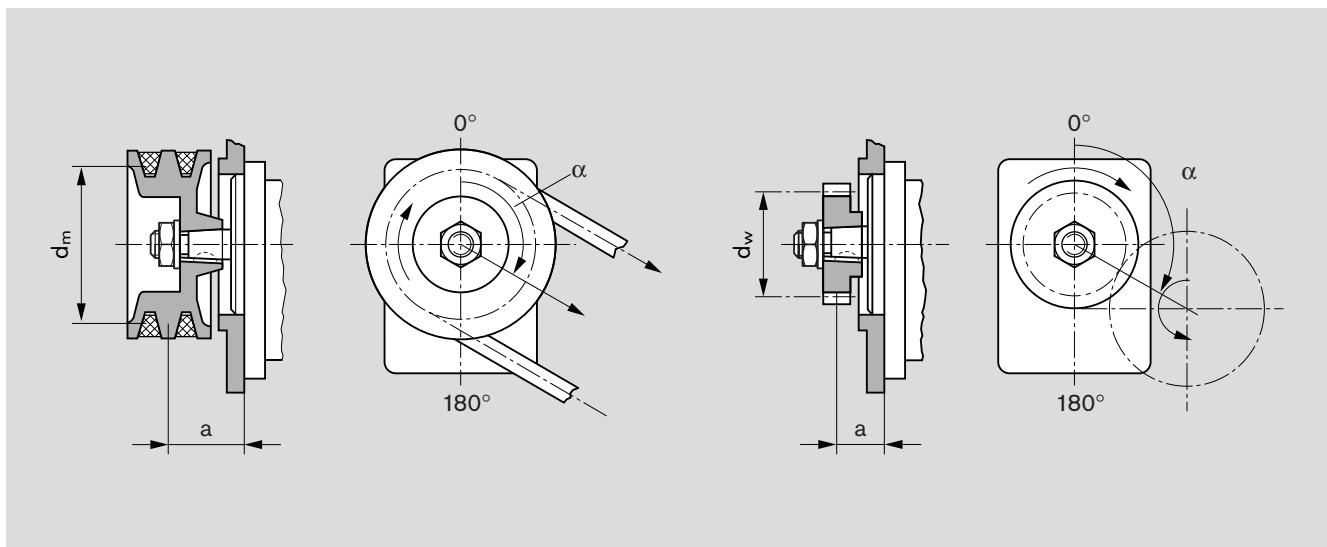

Multiple gear pumps

Gear pumps are well-suited to tandem combinations of pumps in which the drive shaft of the first pump is extended to drive a second pump and sometimes a third pump in the same manner. A coupling is fitted between each pair of pumps. In most cases each pump is isolated from its neighbor, i.e. the suction ports are separate from one another. A common suction port is also possible as an option.

Caution: Basically, the specifications for the single pumps apply, but with certain restrictions:

Max. speed: This is determined by the highest rated pump speed in use.

Pressures: These are restricted by the strength of the drive shaft, the through drives and the drivers. Appropriate data is given in the dimensional drawings.

Pressure restrictions during standard through drive

In the case of series N, the driver for the second pumping stage can carry a load of up to $M_{max.} = 95 \text{ Nm}$, i.e. there is a pressure restriction for the second stage and any further stages.

Drive shaft		Max. transferrable drive torque * [Nm]
C	1:5	200
N	Claw	95
D	SAE 13t	320
P	SAE 11t	180

* These values only apply when the conditions described above are complied with. Bosch Rexroth is to be consulted if the stated values are exceeded.

If the first stage is driven through a tang (driver) or outboard bearing type 1, pressure restrictions apply as indicated in the formula below.

Reinforced through drives are available for applications with higher transfer torques and/or rotational vibrations. Customized designs available on request.

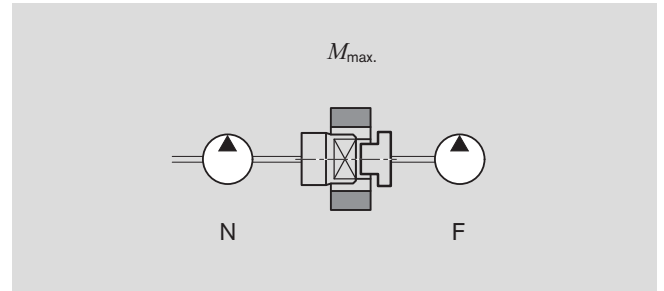

Combinations

Series pump 1	$M_{max.}$ [Nm]	Series pump 2
N	95	N
N	65	F

For configuration of multiple pumps we recommend the pump is positioned with the largest displacement on the drive side.

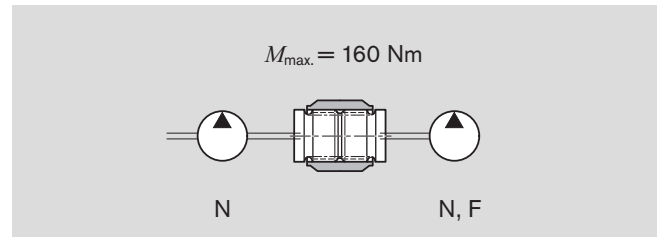

$$M_{max.} \cong \Delta p_1 \cdot V_1 \cdot 0.0177 + \Delta p_2 \cdot V_2 \cdot 0.0177 + \Delta p_3 \cdot V_3 \cdot 0.0177$$

Δp [bar] V [cm³/rev]

Dimensions

Standard range

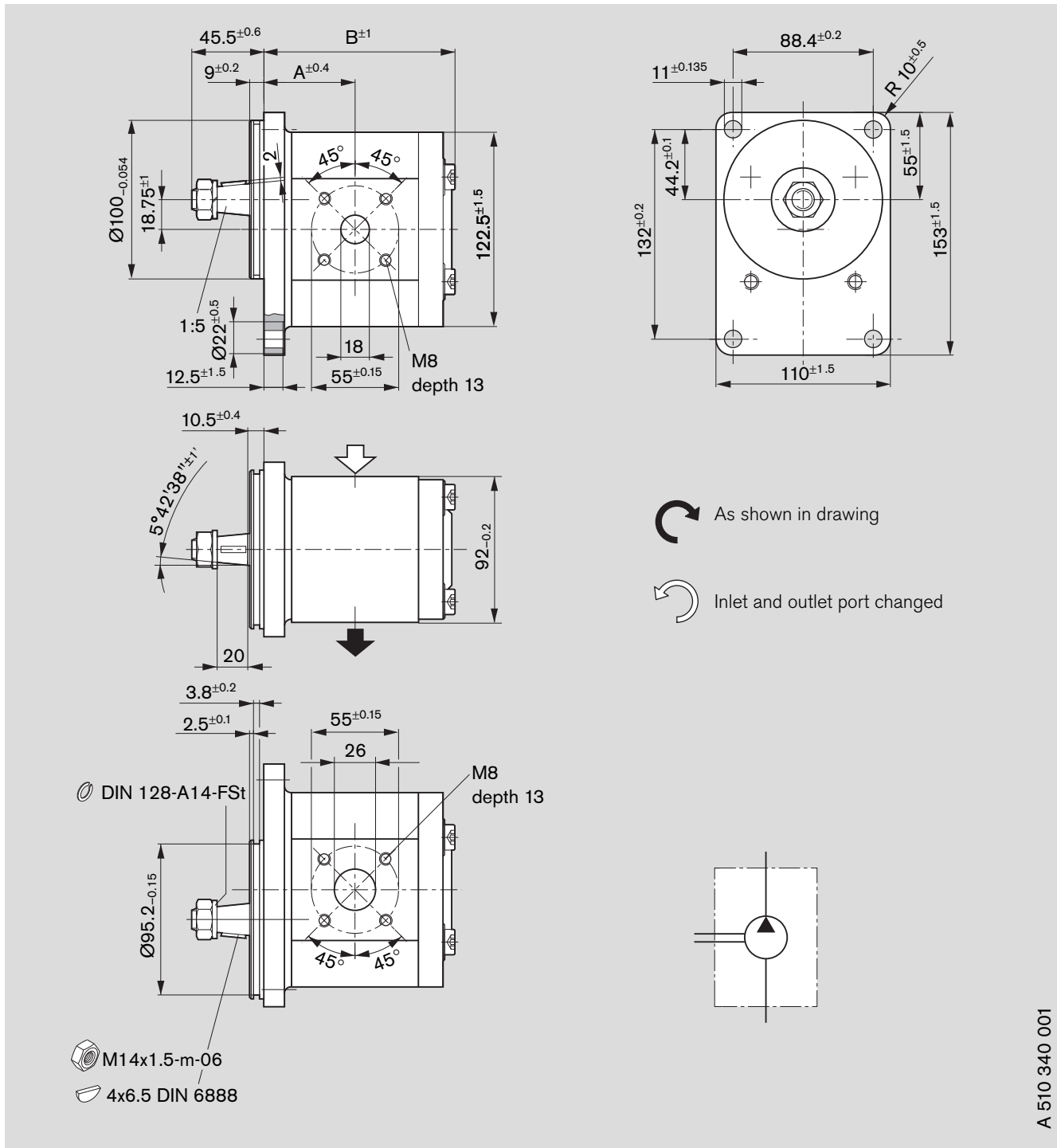

Ordering code:

AZPN - 11 - C B 20 M B

Displacement [cm ³ /rev]	Ordering-No.		Max. operating pressure [bar]	Max. rotation speed [rpm]	kg	Dimension [mm]	
	L	R				A	B
20	0 510 625 335	0 510 625 035	250	3000	5.4	52	109.8
22.5			250	3000		53.5	112.8
25	0 510 725 352	0 510 725 047	250	3000	5.6	55	115.8
28	0 510 725 364	0 510 725 055	230	2800	5.7	56.5	118.8
32	0 510 725 353	0 510 725 048	200	2800	5.9	59	123.3

Dimensions

Standard range

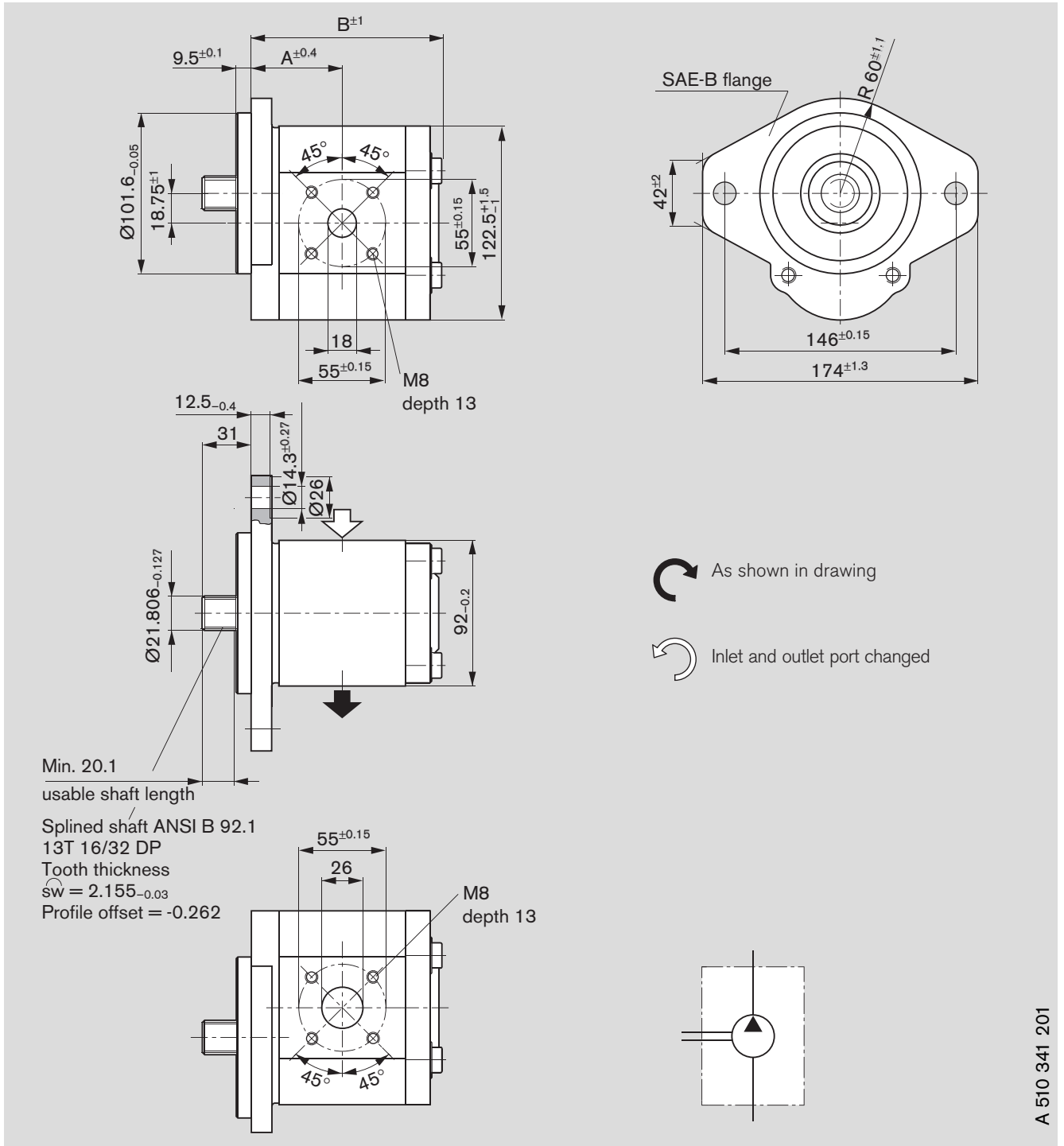



A 510 341 201

Ordering code:

AZPN - 1X - D C 20 M B

AZPN - 1X - D C 20 K B*

Displacement [cm ³ /rev]	Ordering-No.		Max. operating pressure [bar]	Max. rotation speed [rpm]	kg	Dimension [mm]	
	 L	 R				A	B
20			3000	250		52	110.1
22.5			3000	250		53.5	112.6
25	0 510 725 377	0 510 725 057	3000	250	5.5	55	115.3
25		0 510 725 094*	3000	250	5.5	55	115.3
28	0 510 725 431	0 510 725 058*	2800	230	5.7	56.5	118.3
36	0 510 725 363	0 510 725 155	2600	180	6.0	61	127.3

Dimensions

Standard range

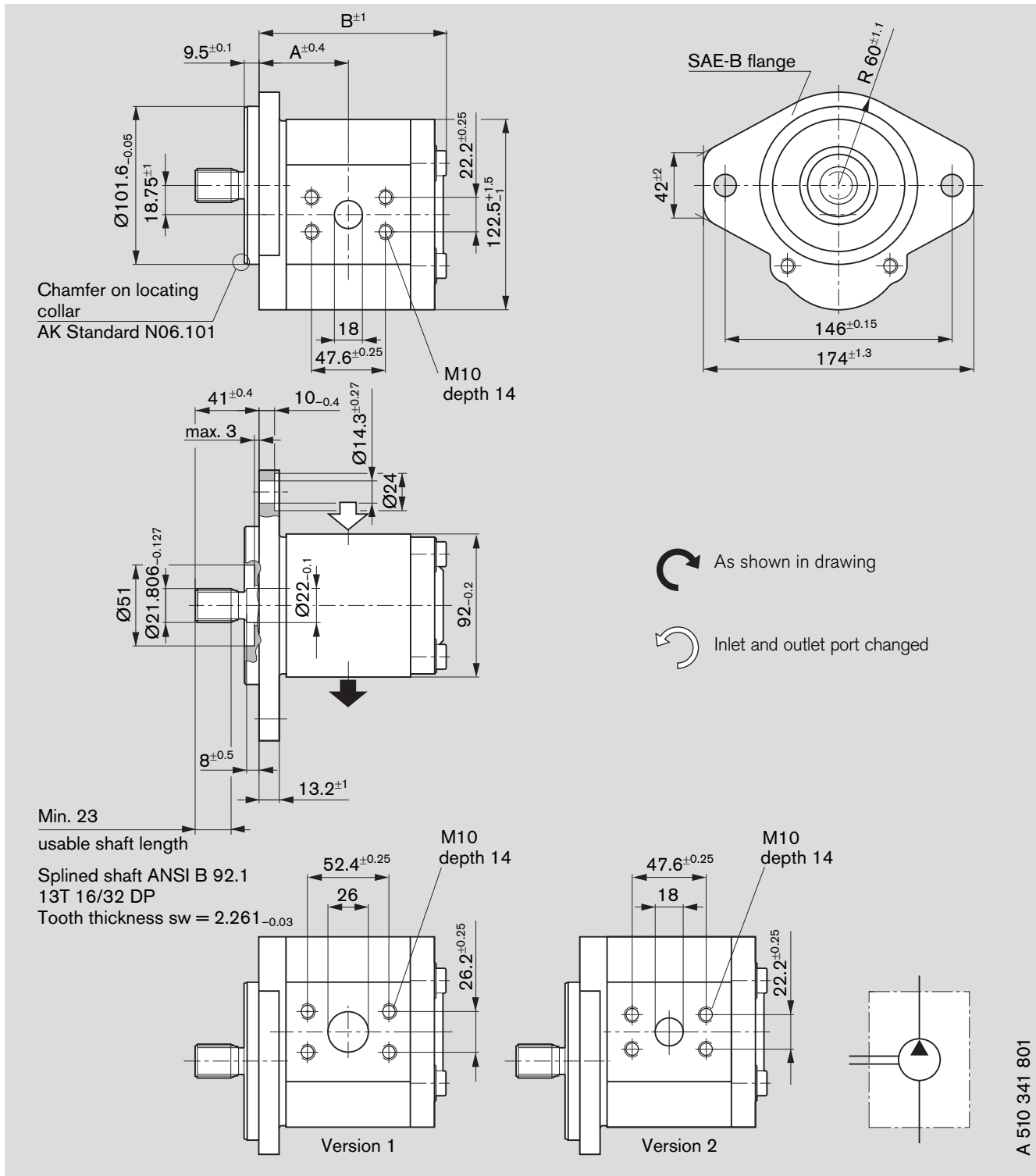

Ordering code:

AZPN - 11 - D C 07 K B S0023

Displacement [cm ³ /rev]	Ordering-No.		Max. operating pressure [bar]	Max. rotation speed [rpm]	kg	Dimension [mm]		Version
	L	R				A	B	
20	0 510 625 380	0 510 625 073	250	3000	5.3	52	109.8	2
22.5	0 510 725 404	0 510 725 103	250	3000	5.4	52	112.8	1
25	0 510 725 405	0 510 725 104	250	3000	5.5	55	115.8	1
28	0 510 725 406	0 510 725 105	230	2800	5.7	56.5	118.8	1
32	0 510 725 407	0 510 725 106	200	2800	5.8	59	123.3	1
36			180	2600		61	127.8	1

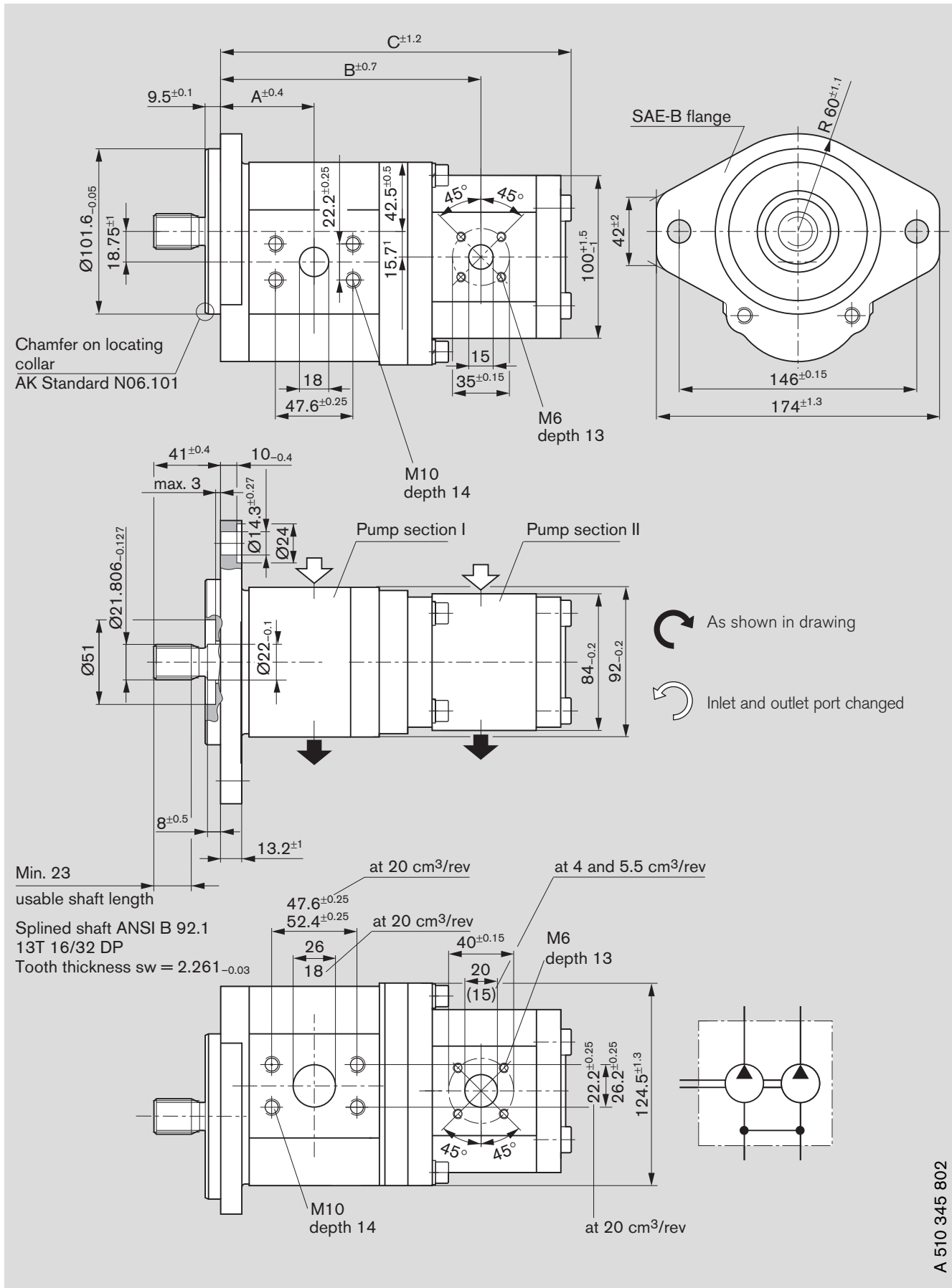

Dimensions

Standard range



Ordering code:

AZPNF – 1X – D C 07 20 K B S0023AZPNF – 1X – D C 07 20 K B S0081*AZPNF – 1X – D C 07 20 M B S0081**

Displacement [cm ³ /rev] P I	Displacement [cm ³ /rev] P II	Ordering-No.		Max. operating pressure [bar] P I	Max. operating pressure [bar] P II	Max. rotation speed [rpm]	kg	Dimension [mm]		
		 L	 R					A	B	C
20	4		0 510 665 181	250	280	3000	–	52.0	141.5	184.2
22.5	8	0 510 765 387*	0 510 765 078	250	280	3000	8.4	53.5	147.9	193.8
22.5	11	0 510 765 381	0 510 765 062	250	280	3000	8.5	53.5	151.7	200.6
25	4	0 510 766 316		250	280	3000	–	55.0	147.6	190.2
25	11	0 510 765 377	0 510 765 079	250	280	3000	8.6	55.0	154.7	203.6
25	14		0 510 766 014**	250	250	3000	8.7	55.0	155.2	206.8
25	16		0 510 765 080	250	230	3000	8.8	55.0	155.2	210.2
28	11		0 510 765 092	230	280	2800	8.7	56.5	157.7	206.6
28	16	0 510 765 384	0 510 765 063	230	230	2800	8.9	56.5	158.2	213.2
28	19	0 510 766 314	0 510 767 058	200	200	2800	9.0	56.5	158.2	219.8
28	22.5		0 510 767 045	230	200	2100	9.2	56.5	165.8	223.6
28	22.5	0 510 767 322*		230	150	2100	9.3	56.5	165.8	223.6
32	8		0 510 765 064	200	280	2500	8.8	59.0	158.4	204.3
32	11	0 510 768 320	0 510 765 065	200	280	2500	8.9	59.0	162.2	211.1
32	14	0 510 765 378		200	250	2500	9.0	59.0	162.7	216.1
32	16		0 510 765 066	200	230	2500	9.1	59.0	162.7	217.7
32	22.5	0 510 768 318*		200	150	2100	–	59.0	170.3	229.9

Fittings

Fittings can be used for rectangular flange **20** see page 7

Gear pump flange, 90° angle

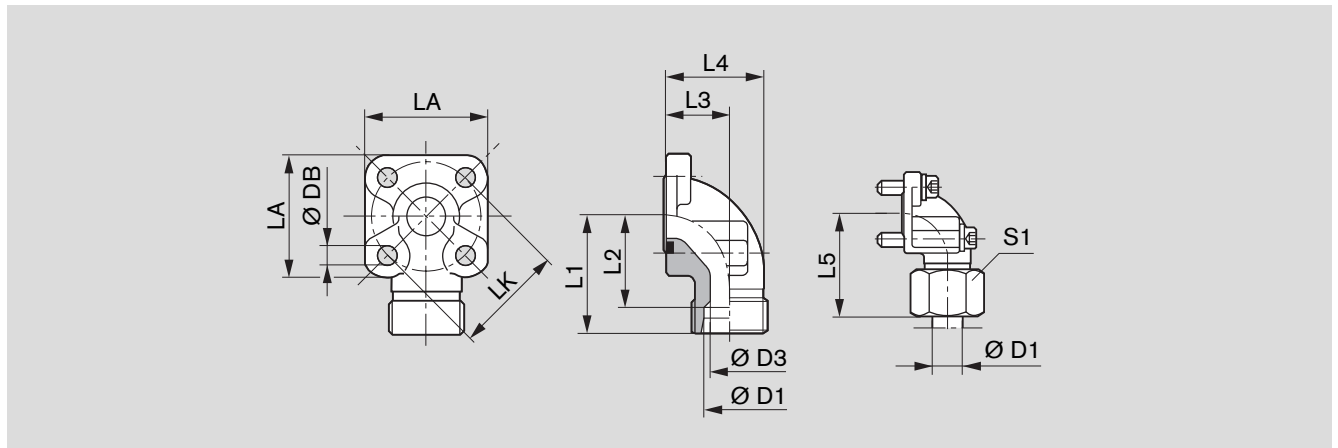

LK	D1	D3	L1	L2	L3	L4	L5	LA	S1	DB	Screws		Seal ring	Mass kg	Part number	p (bar)
											2x	2x				
55	20S	17	45	34.5	24.0	40.0	56.0	58	36	8.4	M 8x25	M 8x50	33x2.5	0.44	1 515 702 004	250
55	30S	26	49	35.5	32.0	50.0	62.0	58	50	8.4	M 8x25	M 8x50	33x2.5	0.50	1 515 702 006	250
55	35L	31	49	38.5	32.0	51.5	62.0	58	50	8.4	M 8x25	M 8x60	32x2.5	0.47	1 515 702 005	100
55	42 L	38	49	38.0	40.0	64.5	61.0	58	60	8.4	M 8x25	M 8x70	32x2.5	0.60	1 515 702 019	100

Complete fittings with seal ring, metric screw set, nuts and olive.

Note

You can find the permissible tightening torques in our publication:

“General Operating Instructions for External Gear Units”

RE 07 012-B1.

Service parts

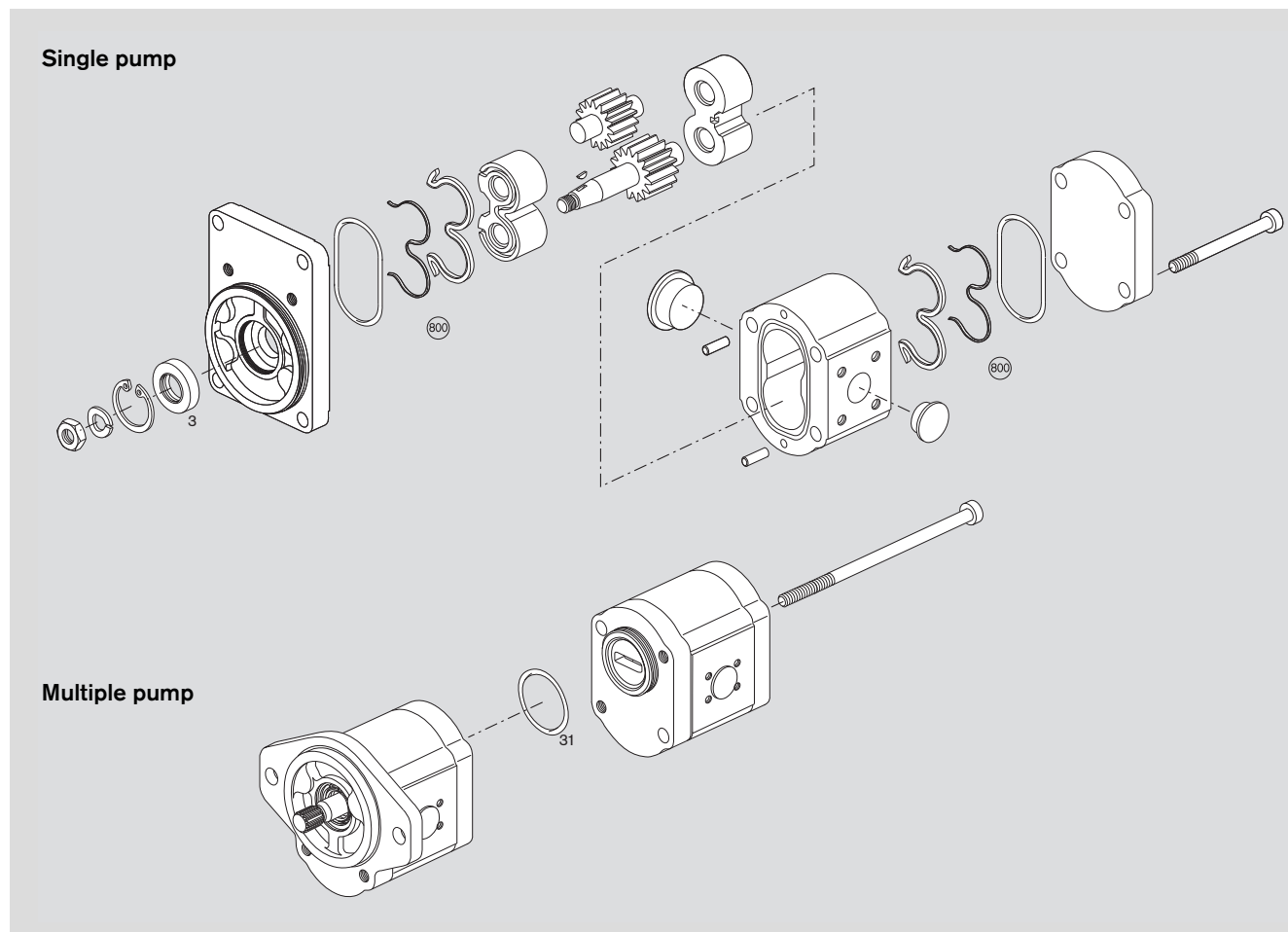

Page	Ordering code	Seal kit "N" Pos. 800 NBR	Seal kit "F" Pos. 800 NBR	Shaft seal ring Pos. 3	Dimen- sion	Seal ring Pos. 3.1	Material	Dimension
16	AZPN - 1X - □□□ □ C B 20 M B	1517010226		1510283023	40x22x7		NBR	
17	AZPN - 1X - □□□ □ D C 20 M B	1517010226		1510283023	40x22x7		NBR	
17	AZPN - 1X - □□□ □ D C 20 K B	1517010226		1510283028	40x22x7		FKM (SSR)	
18	AZPN - 1X - □□□ □ D C 07 K B S0023	1517010226		1510283028	40x22x7		FKM (SSR)	
19	AZPNF - 1X - □□□ □ D C 07 07 K B S0023	1517010226	1517010208	1510283028	40x22x7	1510210043	FKM (SSR)	60x2.5 FPM
20	AZPNF - 1X - □□□ □ D C 07 20 K B S0081	1517010226	1517010208	1510283028	40x22x7	1510210043	FKM (SSR)	60x2.5 FPM
20	AZPNF - 1X - □□□ □ D C 07 20 M B S0081	1517010226	1517010208	1510283028	40x22x7	1510210043	FKM (SSR)	60x2.5 FPM
20	AZPNN - 1X - □□□ □ D C 07 20 K B S0023	1517010226	1517010226	1510283028	40x22x7	1900210145	FKM (SSR)	45x2.5 NBR

NBR = Perbunan® FKM = Viton®

Notes for commissioning

Filter recommendation

The major share of premature failures in external gear pumps is caused by contaminated hydraulic fluid.

As a warranty cannot be issued for dirt-specific wear, we recommend filtration compliant with cleanliness level 20/18/15 ISO 4406, which reduces the degree of contamination to a permissible dimension in terms of the size and concentration of dirt particles:

Operating pressure [bar]	>160	<160
Contamination class ISO 4406	18/15	19/16
To be reached with $\beta_x = 75$	20	25

We recommend that a full-flow filter always be used. Basic contamination of the hydraulic fluid used may not exceed class 20/18/15 according to ISO 4406. Experience has shown that new fluid quite often lies above this value. In such instances a filling device with special filter should be used.

General

- The pumps supplied by us have been checked for function and performance. No modifications of any kind may be made to the pumps; any such changes will render the warranty null and void!
- Pump may only be operated in compliance with permitted data (see pages 15 – 18).

Project planning notes

Comprehensive notes and suggestions are available in Hydraulics Trainer, Volume 3 RE 00 281, "Project planning notes and design of hydraulic systems". Where external gear pumps are used we recommend that the following note be adhered to.

Technical data

All stated technical data is dependent on production tolerances and is valid for specific marginal conditions.

Note that, as a consequence, scattering is possible, and at certain marginal conditions (e.g. viscosity) **the technical data may change.**

Characteristics

When designing the external gear pump, note the maximum possible service data based on the characteristics displayed on pages 10 to 12.

Additional information on the proper handling of hydraulic products from Bosch Rexroth is available in our document: "General product information for hydraulic products" RE 07 008.

Contained in delivery

The components with characteristics as described under ordering code and device measurements, pages 16 – 20, are contained in delivery.

You can find further information in our publication: "General Operating Instructions for External Gear Units" RE 07 012-B1.

Ordering-No.

Ordering-No.	Page	Ordering-No.	Page	Ordering-No.	Page	Ordering-No.	Page
0 510 625 035	16	0 510 725 105	18	0 510 765 064	21	0 510 765 380	19
0 510 625 073	18	0 510 725 106	18	0 510 765 065	21	0 510 765 381	21
0 510 625 335	16	0 510 725 155	17	0 510 765 066	21	0 510 765 384	21
0 510 625 380	18	0 510 725 352	16	0 510 765 067	19	0 510 765 387	21
0 510 665 149	19	0 510 725 353	16	0 510 765 068	19	0 510 766 014	21
0 510 665 181	21	0 510 725 363	17	0 510 765 069	19	0 510 766 314	21
0 510 665 461	19	0 510 725 364	16	0 510 765 078	21	0 510 766 315	19
0 510 725 047	16	0 510 725 377	17	0 510 765 079	21	0 510 766 316	21
0 510 725 048	16	0 510 725 404	18	0 510 765 080	21	0 510 767 045	21
0 510 725 055	16	0 510 725 405	18	0 510 765 086	19	0 510 767 058	21
0 510 725 057	17	0 510 725 406	18	0 510 765 092	21	0 510 767 322	21
0 510 725 058	17	0 510 725 407	18	0 510 765 369	19	0 510 768 034	19
0 510 725 094	17	0 510 725 431	17	0 510 765 370	19	0 510 768 318	21
0 510 725 103	18	0 510 765 062	21	0 510 765 377	21	0 510 768 320	21
0 510 725 104	18	0 510 765 063	21	0 510 765 378	21		

The AZ configurator at www.boschrexroth.com/azconfigurator

The AZ configurator assists you to configure your individual external gear unit easily and user-friendly. You only need to specify your requirements: From the displacement, direction of rotation, drive shaft, connection flange right up to the required rear cover. You immediately receive a project drawing (PDF format) if a configuration already exists. You receive the price of the configured external gear unit upon request.



The AZ configurator assists you to configure your individual external gear unit easily and user-friendly – all data needed for project planning are acquired thru menu guidance.



Selection is made either on an ordering code or your technical requirements. This means that you can search for external gear units that have already been configured, or you specify the configuration variant of the external gear unit based upon the operating parameters you require.



If the external gear unit you selected has been released you will receive the part number, ordering code and a detailed installation drawing. If your special configuration is not available please send your specification to Rexroth. One of our employees will then contact you.

Bosch Rexroth AG
 External Gear Units
 Robert-Bosch-Straße 2
 D-71701 Schwieberdingen
 Phone +49 (0) 711-811 10 63
 Fax +49 (0) 711-811 17 98
brm-az.info@boschrexroth.de
www.boschrexroth.com/brm

© This document, as well as the data, specifications and other information set forth in it, are the exclusive property of Bosch Rexroth AG. It may not be reproduced or given to third parties without its consent. The data specified above only serve to describe the product. No statements concerning a certain condition or suitability for a certain application can be derived from our information. The information given does not release the user from the obligation of own judgement and verification. It must be remembered that our products are subject to a natural process of wear and aging.