

# External gear pump Series U

**RE 10 098/02.12**

Replaces

RE 10 098/08.07

AZPU-...

Fixed pumps  
 $V = 22.5 \dots 63 \text{ cm}^3/\text{rev}$



## Overview of contents

### Contents

General	
Product overview	
Ordering code single pumps	
Ordering code multiple pumps	
Drive shaft	
Front cover	
Line ports	
Pumps with integral valves	
Design calculations for pumps	
Performance charts	
Noise charts	
Specifications	
Drive arrangements	
Multiple pumps through drives	
Dimensions	
Fittings	
Notes on commissioning and maintenance	
Service parts	
Ordering-No.	

## Features

Page	
	– Nominal pressure 280 bar
2	– Slide bearings for heavy duty applications
3	– Drive shafts to ISO or SAE
4	– Combination of several pumps possible
5	– Line ports: connection flanges
6	– Optimized pressure pulsation, which reduces noise emissions and vibration input in system
7	– Long service life thru reinforced design of shafts and case
8	– Consistent high quality thru mass production
9	– Numerous configuration variants available
12	
14	
15	
17	
18	
22	
23	
24	
26	

## General

The key task of external gear units is to convert mechanical energy (torque and rotational speed) into hydraulic energy (flow and pressure). In external gear motors this is the other way round. These machines are required to be highly efficient in order to avoid unnecessary heat. This efficiency is achieved by means of precision production engineering and pressure-sensitive gap sealing.

Moreover, in the low-noise SILENCE pumps, the dual-flank principle helps to reduce flow pulsation by up to 75%.

### The displacement method

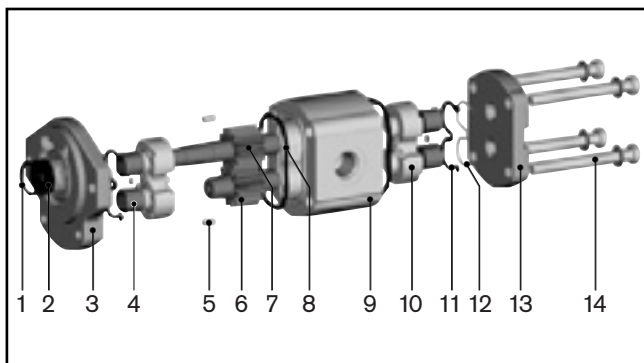
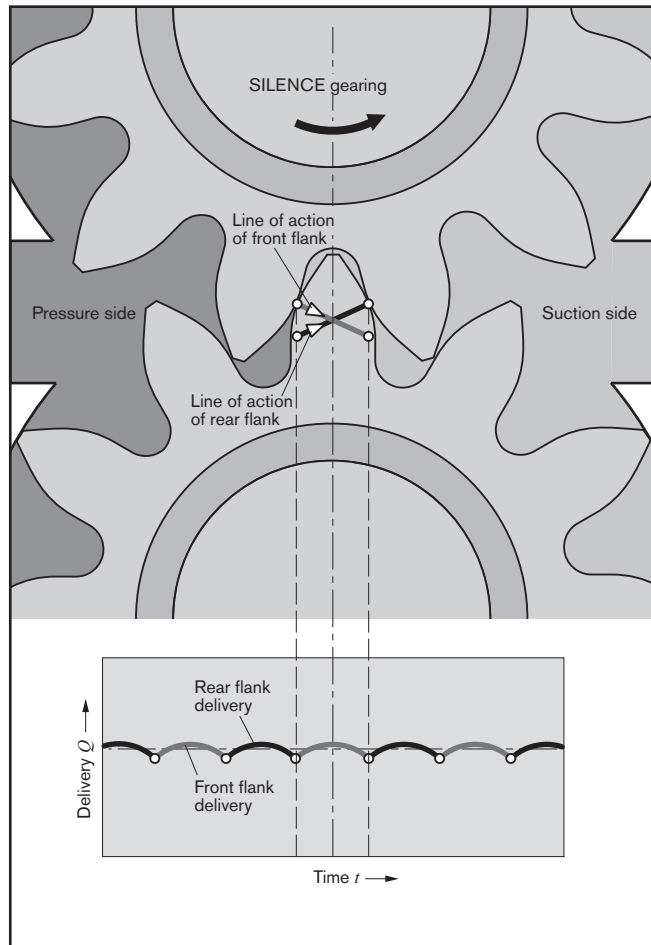
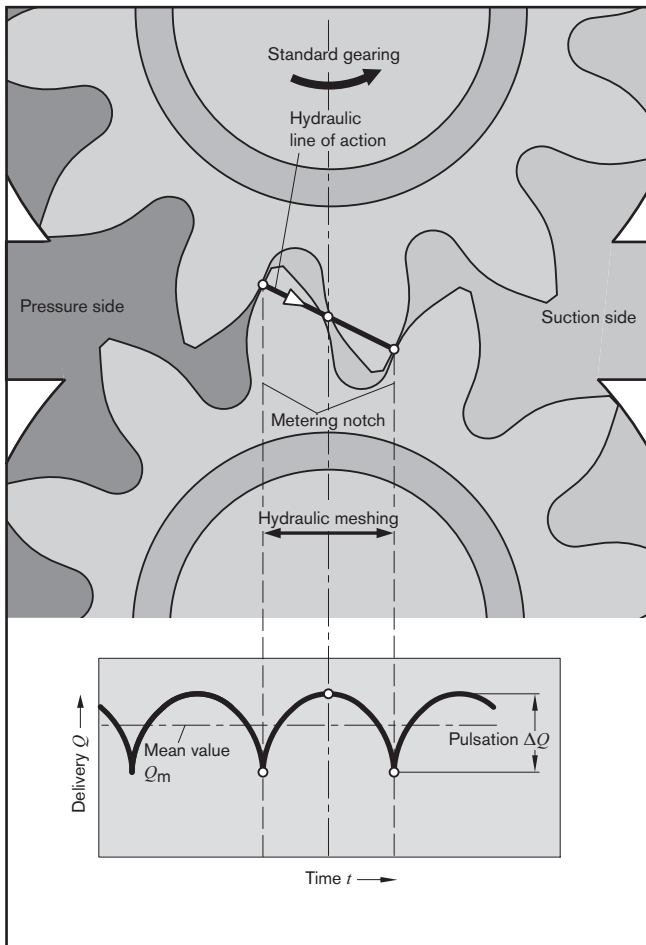

- |                     |                    |
|---------------------|--------------------|
| 1 Retaining ring    | 8 Case seal        |
| 2 Shaft seal ring   | 9 Pump case        |
| 3 Front cover       | 10 Bearing         |
| 4 Slide bearing     | 11 Axial zone seal |
| 5 Centering pin     | 12 Support         |
| 6 Gear              | 13 End cover       |
| 7 Gear (frictional) | 14 Fixing screws   |

The geometry of the displacement gearing, matched in form by the rotation of the drive shaft, results in the parabolic flow characteristic shown here on the left. In a standard pump, this characteristic is repeated each time a gear tooth meshes. With their dual-flank system, the flow pulsation of SILENCE pumps is reduced by 75% – with correspondingly lower excitation of downstream system components – at double the fundamental frequency. During this process, the gear pair exhibits an extremely reduced rear flank backlash, so that hydraulic sealing is provided not just by the front flank of the driven gear, but also by the rear flanks. In this way, the front and rear flanks alternately contribute to flow displacement. And by adapting the shape of the metering notches, the expansion of the hydraulic line of action is half that of the standard pump.

### Construction

The external gear pump consists essentially of a pair of gears supported in bearing bushings or bearing, dependent on the series, and the case with a front and rear cover. The drive shaft protrudes from the front cover where it is sealed by the shaft seal ring. The bearing forces are absorbed by special slide bearings with sufficient elasticity to produce surface contact instead of line contact. They also ensure excellent resistance to galling – especially at low speed. The gears have 12 teeth. This keeps both flow pulsation and noise emission to a minimum.

The internal sealing is achieved by forces which are proportional to delivery pressure. This ensures optimum efficiency. The sealing zone between the gear teeth and the bearings is controlled by the admission of operating pressure to the rear of the bearing bushings. Special seals form the boundary of the zone. The radial clearance at the tips of the gear teeth is sealed by internal forces pushing them against the case.

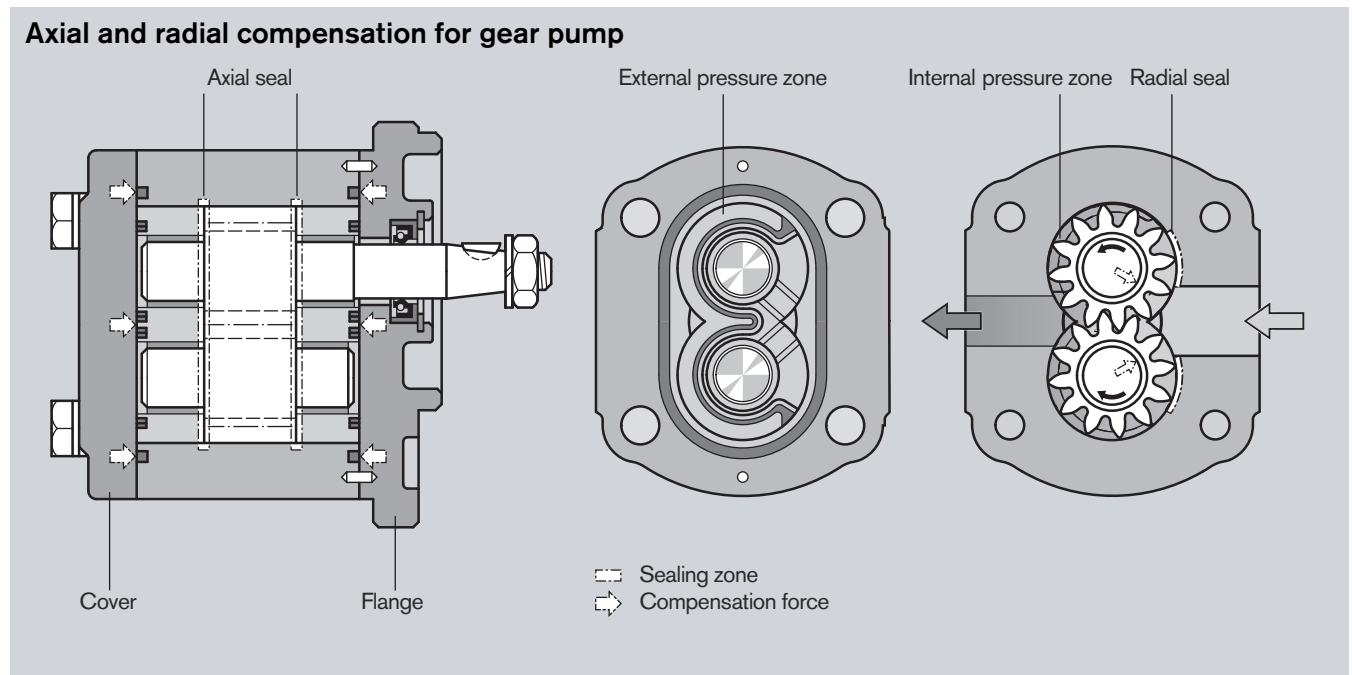



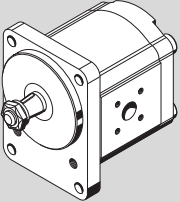

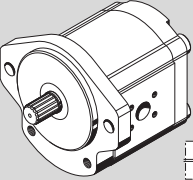



### Overview of “Series U” standard types

Version	Page
	18

Version	Page
	19 20 21

# Ordering code





























## External gear units Single pumps "SILENCE"

<b>AZ</b>	<b>P</b>	<b>U</b>	<b>-</b>	<b>2</b>	<b>2</b>	<b>-</b>	<b>063</b>	<b>R</b>	<b>C</b>	<b>B</b>	<b>20</b>	<b>M</b>	<b>D</b>	<b>18009</b>	<b>S xxxx</b>																									
<table border="1"> <tr> <td><b>Function</b></td> <td rowspan="2">Special design *)</td> </tr> <tr> <td><b>P = Pump</b></td> </tr> <tr> <td><b>Series</b></td> <td rowspan="2">Valve adjustment</td> </tr> <tr> <td><b>2 = 2nd generation</b></td> </tr> <tr> <td><b>Version</b></td> <td rowspan="2">Rear cover</td> </tr> <tr> <td><b>2 = corrosion-resistant, pinned</b></td> </tr> <tr> <td><b>Size G</b></td> <td rowspan="2">Seals</td> </tr> <tr> <td><b>022 = 22.5 cm<sup>3</sup>/rev</b></td> </tr> <tr> <td><b>025 = 25.0 cm<sup>3</sup>/rev</b></td> <td rowspan="2">M = NBR</td> </tr> <tr> <td><b>028 = 28.0 cm<sup>3</sup>/rev</b></td> </tr> <tr> <td><b>032 = 32.0 cm<sup>3</sup>/rev</b></td> <td rowspan="2">K = NBR, SSR in FKM</td> </tr> <tr> <td><b>036 = 36.0 cm<sup>3</sup>/rev</b></td> </tr> <tr> <td><b>040 = 40.0 cm<sup>3</sup>/rev</b></td> <td rowspan="2">Direction of rotation</td> </tr> <tr> <td><b>045 = 45.0 cm<sup>3</sup>/rev</b></td> </tr> <tr> <td><b>050 = 50.0 cm<sup>3</sup>/rev</b></td> <td rowspan="2">R = Clockwise</td> </tr> <tr> <td><b>056 = 56.0 cm<sup>3</sup>/rev</b></td> </tr> <tr> <td><b>063 = 63.0 cm<sup>3</sup>/rev</b></td> <td rowspan="2">L = Counterclockwise</td> </tr> </table>															<b>Function</b>	Special design *)	<b>P = Pump</b>	<b>Series</b>	Valve adjustment	<b>2 = 2nd generation</b>	<b>Version</b>	Rear cover	<b>2 = corrosion-resistant, pinned</b>	<b>Size G</b>	Seals	<b>022 = 22.5 cm<sup>3</sup>/rev</b>	<b>025 = 25.0 cm<sup>3</sup>/rev</b>	M = NBR	<b>028 = 28.0 cm<sup>3</sup>/rev</b>	<b>032 = 32.0 cm<sup>3</sup>/rev</b>	K = NBR, SSR in FKM	<b>036 = 36.0 cm<sup>3</sup>/rev</b>	<b>040 = 40.0 cm<sup>3</sup>/rev</b>	Direction of rotation	<b>045 = 45.0 cm<sup>3</sup>/rev</b>	<b>050 = 50.0 cm<sup>3</sup>/rev</b>	R = Clockwise	<b>056 = 56.0 cm<sup>3</sup>/rev</b>	<b>063 = 63.0 cm<sup>3</sup>/rev</b>	L = Counterclockwise
<b>Function</b>	Special design *)																																							
<b>P = Pump</b>																																								
<b>Series</b>	Valve adjustment																																							
<b>2 = 2nd generation</b>																																								
<b>Version</b>	Rear cover																																							
<b>2 = corrosion-resistant, pinned</b>																																								
<b>Size G</b>	Seals																																							
<b>022 = 22.5 cm<sup>3</sup>/rev</b>																																								
<b>025 = 25.0 cm<sup>3</sup>/rev</b>	M = NBR																																							
<b>028 = 28.0 cm<sup>3</sup>/rev</b>																																								
<b>032 = 32.0 cm<sup>3</sup>/rev</b>	K = NBR, SSR in FKM																																							
<b>036 = 36.0 cm<sup>3</sup>/rev</b>																																								
<b>040 = 40.0 cm<sup>3</sup>/rev</b>	Direction of rotation																																							
<b>045 = 45.0 cm<sup>3</sup>/rev</b>																																								
<b>050 = 50.0 cm<sup>3</sup>/rev</b>	R = Clockwise																																							
<b>056 = 56.0 cm<sup>3</sup>/rev</b>																																								
<b>063 = 63.0 cm<sup>3</sup>/rev</b>	L = Counterclockwise																																							
<p>*) Some of the special designs shown on pages 18–21 are not covered in the illustration of the ordering code.</p>																																								
<b>Drive shafts</b>							<b>Front cover</b>					<b>Line ports</b>																												
Suitable front cover																																								
<b>C</b>	Tapered key shaft 1 : 5		<b>B</b>	<b>B</b>	Rectangular flange Centering Ø 105 mm		<b>20</b>	Rectangular flange																																
<b>D</b>	Splined shaft SAE J 744 22-4 13T		<b>C</b>	<b>C</b>	SAE J 744 101-2 B 2-hole flange Ø 101.6 mm		<b>07</b>	Square flange SAE thread, metric																																
<b>H</b>	Tapered key shaft 1 : 8		<b>O</b>	<b>O</b>	Rectangular flange Centering Ø 50.78 mm		<b>30</b>	Rectangular flange																																

Not all variants can be selected by using ordering code!  
 Please select the required pump by using the selection tables (standard types) or after consultation with Bosch Rexroth!  
 Special options are possible upon request.

# Ordering code

## External gear units Multiple pumps "SILENCE"

<b>AZ</b>	<b>P</b>	<b>U</b>	<b>U</b>	<b>S</b>	<b>S</b>	<b>-</b>	<b>032/022/016/005</b>	<b>R</b>	<b>C</b>	<b>B</b>	<b>20</b>	<b>20</b>	<b>20</b>	<b>20</b>	<b>K</b>	<b>B</b>				
<b>Function</b> P = Pump <b>Series</b> B = 1.0...71 cm <sup>3</sup> /rev S = 4.0...28 cm <sup>3</sup> /rev F = 4.0...28 cm <sup>3</sup> /rev T = 20.0...36 cm <sup>3</sup> /rev N = 20.0...36 cm <sup>3</sup> /rev U = 22.5...63 cm <sup>3</sup> /rev G = 22.5...63 cm <sup>3</sup> /rev <b>Series</b> , relates to pump section 1 2 = 2nd generation <b>Version</b> , relates to pump section 1 2 = corrosion-resistant, pinned <b>Size</b> as per individual Series <b>Direction of rotation</b> R = Clockwise L = Counterclockwise							<b>Rear cover</b> relates to last pump part B = Standard <b>Seals</b> M = NBR P = FKM K = NBR, WDR in FKM WDR relates to pump part 1													
<b>Drive shafts</b> relates to pump part 1 Series B: <b>H</b> Tapered key shaft 1 : 5  <b>O</b> Suitable front cover  <b>O</b> Series F, S: <b>C</b> Tapered key shaft 1 : 5  <b>B</b> <b>H</b> Tapered key shaft 1 : 8  <b>O</b> <b>R</b> Splined shaft SAE J 744 16-4 9T  <b>R</b> Series N, T: <b>C</b> Tapered key shaft 1 : 5  <b>B</b> <b>D</b> Splined shaft SAE J 744 22-4 13T  <b>C</b> Series G, U: <b>C</b> Tapered key shaft 1 : 5  <b>B</b> <b>D</b> Splined shaft SAE J 744 22-4 13T  <b>C</b> <b>H</b> Tapered key shaft 1 : 8  <b>O</b>							<b>Front cover</b> relates to pump part 1 <b>O</b> Square flange Centering Ø 25.38 mm  <b>B</b> Square flange Centering Ø 80 mm  <b>O</b> Square flange Centering Ø 36.47 mm SAE J 744 82-2 A  <b>R</b> 2-bolt flange Ø 82.55 mm  <b>B</b> Square flange Centering Ø 100 mm  <b>C</b> SAE J 744 101-2 B 2-bolt flange Centering Ø 101.6 mm  <b>B</b> Square flange Centering Ø 105 mm  <b>C</b> SAE J 744 101-2 B 2-bolt flange Centering Ø 101.6 mm  <b>O</b> Square flange Centering Ø 50.78 mm 							<b>Line ports</b> every pump parts <b>01</b> Pipe thread ISO 228/1  <b>20</b> Rectangular flange  <b>20</b> Rectangular flange  <b>30</b> Rectangular flange  <b>07</b> Square flange SAE Thread, metric  <b>20</b> Rectangular flange  <b>07</b> Square flange SAE Thread, metric  <b>20</b> Rectangular flange  <b>30</b> Rectangular flange 						

Not all variants can be selected by using ordering code!

Please select the required pump by using the selection tables (standard types) or after consultation with Bosch Rexroth! Special options are possible upon request.

Drive shafts

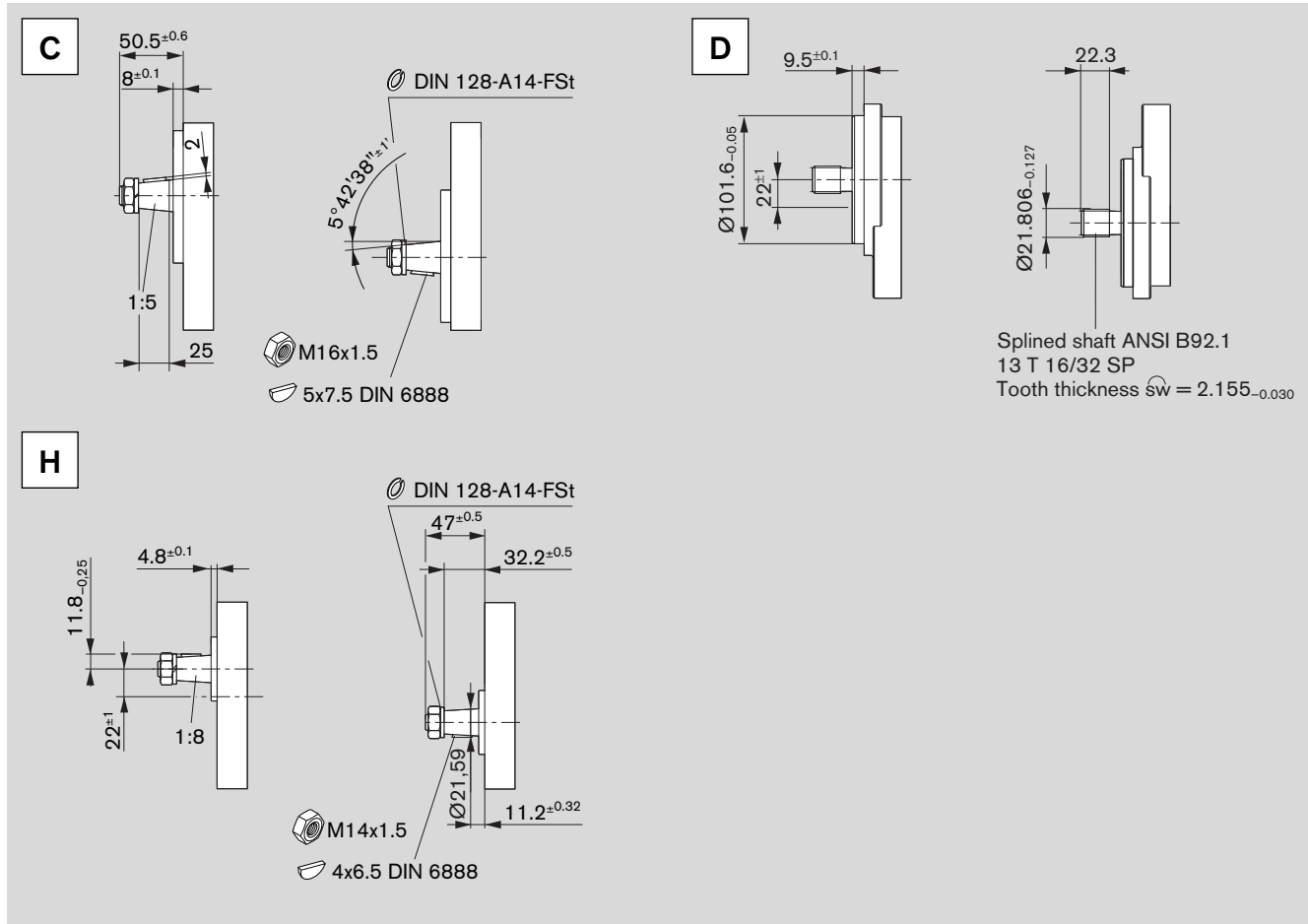

Front cover

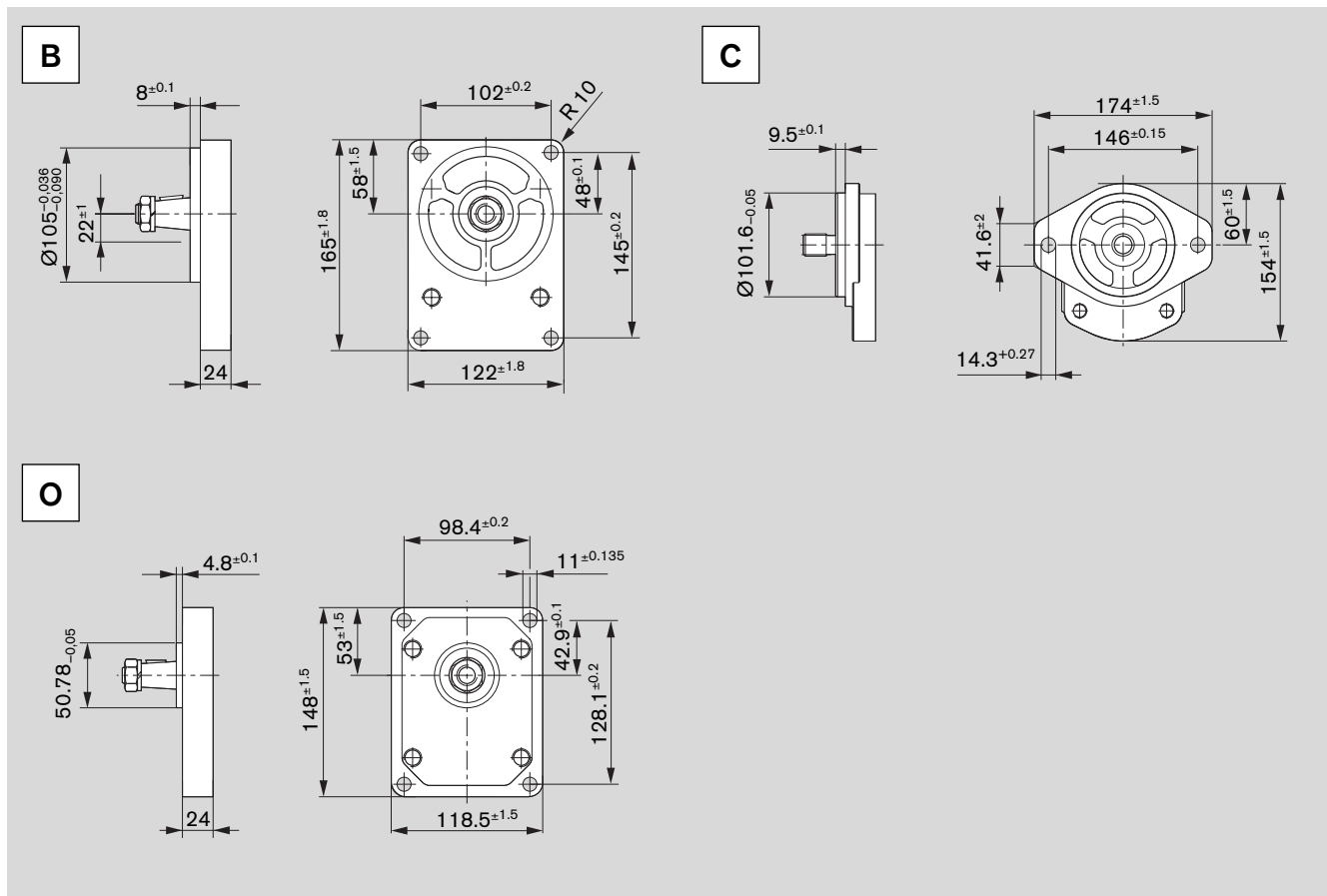

Line ports

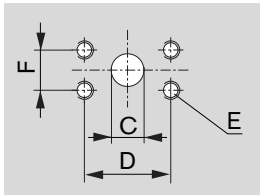

**07** Square flange SAE, thread, metric

Ordering code	Size	Pressure side				Suction side			
		C	D	E	F	C	D	E	F
07	22.5...28 cm <sup>3</sup>	18	47.6	M10 depth 18	22.2	25	52.4	M10 depth 14	26.2
	32.0...50 cm <sup>3</sup>	25	52.4		26.2	32	58.7		30.2
	56.0...63 cm <sup>3</sup>	32	58.7		30.2	38	69.8		35.8

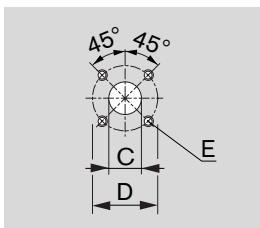

**20** Rectangular flange

Ordering code	Size	Pressure side			Suction side		
		C	D	E	C	D	E
20	22.5...63 cm <sup>3</sup>	18	55	M8 depth 13	26	55	M8 depth 13

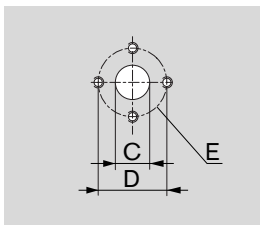

**30** Rectangular flange

Ordering code	Size	Pressure side			Suction side		
		C	D	E	C	D	E
30		18	39.7	M8 depth 13	26	50.8	M10 depth 13

# Gear pumps with integral valves

In order to reduce external pipework it is possible to incorporate a flow-control valve or pressure-relief valve in the cover of the gear pump. Such solutions are used, for example for supplying hydraulic oil to power steering systems. The pump delivers a constant flow irrespective of the speed at which it is driven. The excess flow is either returned internally to the suction port or distributed externally to other items of equipment.

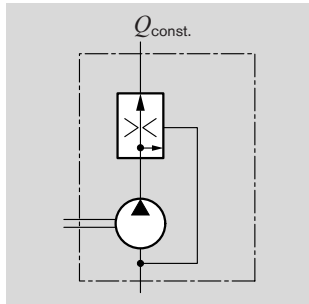
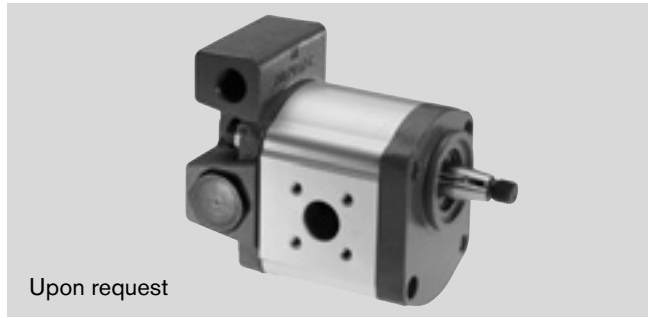

3-way flow-control valve.  
Excess flow returned to suction line  
 $Q_{const.} = 2...30 \text{ l/min}$

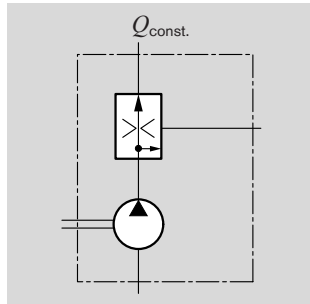

3-way flow-control valve.  
Excess flow distributed externally; loadable  
 $Q_{const.} = 2...30 \text{ l/min}$

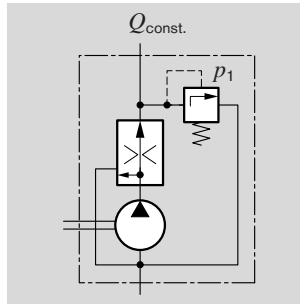

3-way flow-control valve with pressure-relief valve.  
Excess flow returned to suction line  
 $Q_{const.} = 2...30 \text{ l/min}$   
 $p_1 = 100...180 \text{ bar}$

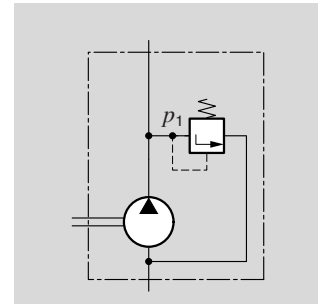

Pressure-relief valve.  
Discharge returned to suction line  
 $p_1 = 5...250 \text{ bar}$

## Ordering code

S	xxx17
---	-------

E	xxx12
---	-------

V	15011
---	-------

D	180xx
---	-------

# Design calculations for pumps

The design calculations for pumps are based on the following parameters:

- $V$  [ $\text{cm}^3/\text{rev}$ ] Displacement
- $Q$  [ $\text{l}/\text{min}$ ] Delivery
- $p$  [ $\text{bar}$ ] Pressure
- $M$  [ $\text{Nm}$ ] Drive torque
- $n$  [ $\text{rev}/\text{min}$ ] Drive speed
- $P$  [ $\text{kW}$ ] Drive power

It is also necessary to allow for different efficiencies such as:

- $\eta_v$  Volumetric efficiency
- $\eta_{hm}$  Hydraulic-mechanical efficiency
- $\eta_t$  Overall efficiency

The following formulas describe the various relationships.

They include correction factors for adapting the parameters to the usual units encountered in practice.

**Caution:** Diagrams providing approximate selection data will be found on subsequent pages.

$$Q = V \cdot n \cdot \eta_v \cdot 10^{-5}$$

$$p = \frac{M \cdot \eta_{hm}}{1.59 \cdot V}$$

$$P = \frac{p \cdot Q}{6 \cdot \eta_t}$$

$$V = \frac{Q}{n \cdot \eta_v} \cdot 10^5$$

$$V = \frac{M \cdot \eta_{hm}}{159 \cdot p}$$

$$Q = \frac{6 \cdot P \cdot \eta_t}{p}$$

$$n = \frac{Q}{V \cdot \eta_v} \cdot 10^5$$

$$M = \frac{1.59 \cdot V \cdot p}{\eta_{hm}}$$

$$p = \frac{6 \cdot P \cdot \eta_t}{Q}$$

[%]

$n$  —  $\eta_v$  —  $Q$       $V$  [ $\text{cm}^3/\text{rev}$ ]    $Q$  [ $\text{l}/\text{min}$ ]    $p$  [ $\text{bar}$ ]

$M$  —  $\eta_{hm}$  —  $p$

$P$  —  $\eta_t$  —  $P \cdot Q$       $n$  [ $\text{rev}/\text{min}$ ]    $P$  [ $\text{kW}$ ]    $M$  [ $\text{Nm}$ ]

**Caution:**  $\eta$  [%] e.g. 95 [%]



# Performance charts

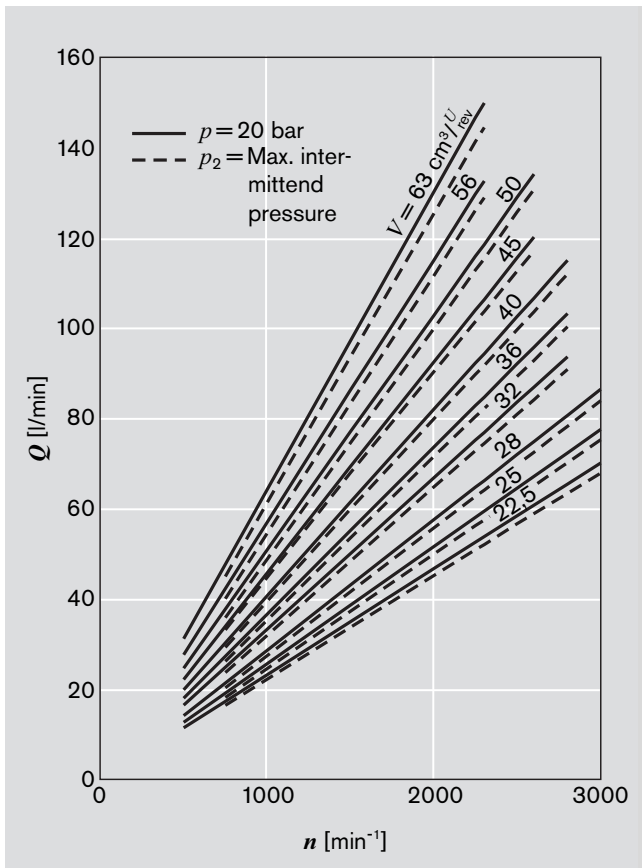

$\nu = 35 \text{ mm}^2/\text{s}, \vartheta = 50^\circ\text{C}$

$Q = f(n, V)$  incl.  $\eta_v$   
 $P = f(n, p)$  ——— incl.  $\eta_t$   
 $M = f(n, p)$  - - - incl.  $\eta_{hm}$

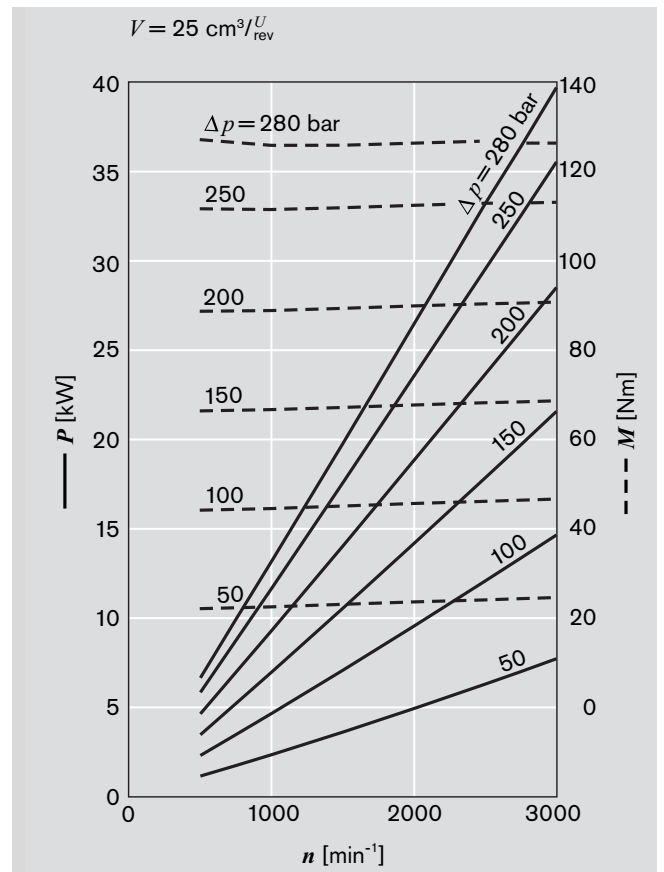
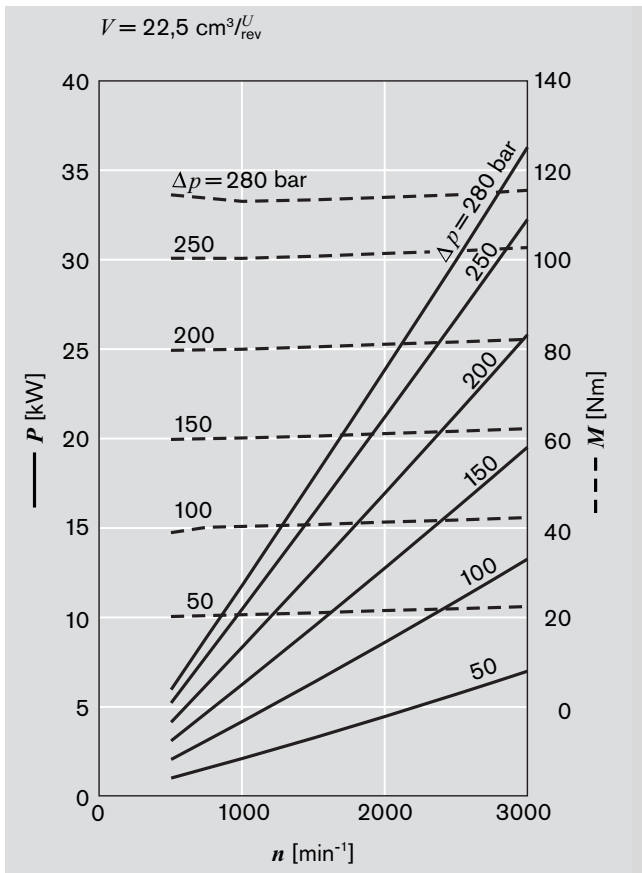

Performance charts (continued)

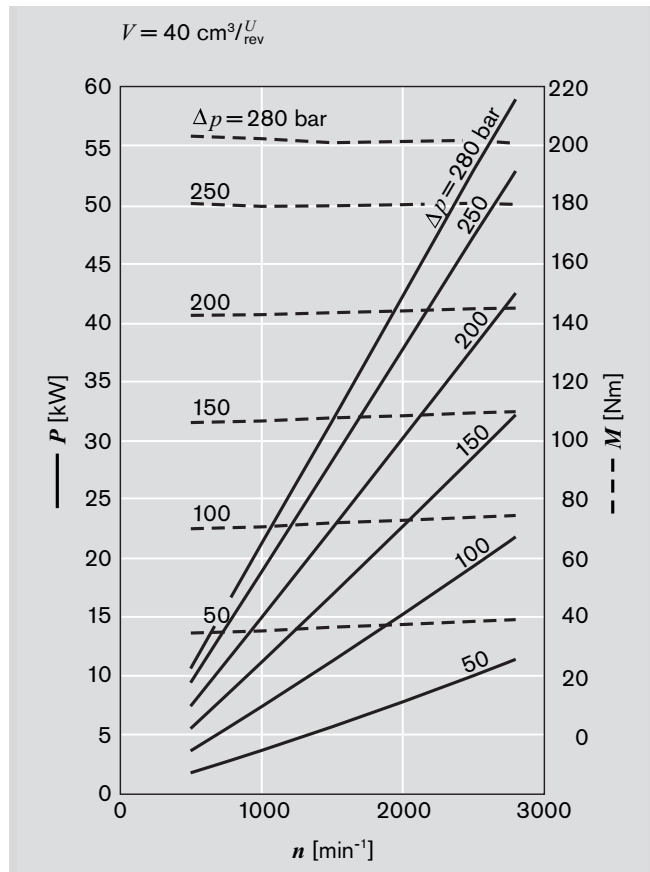
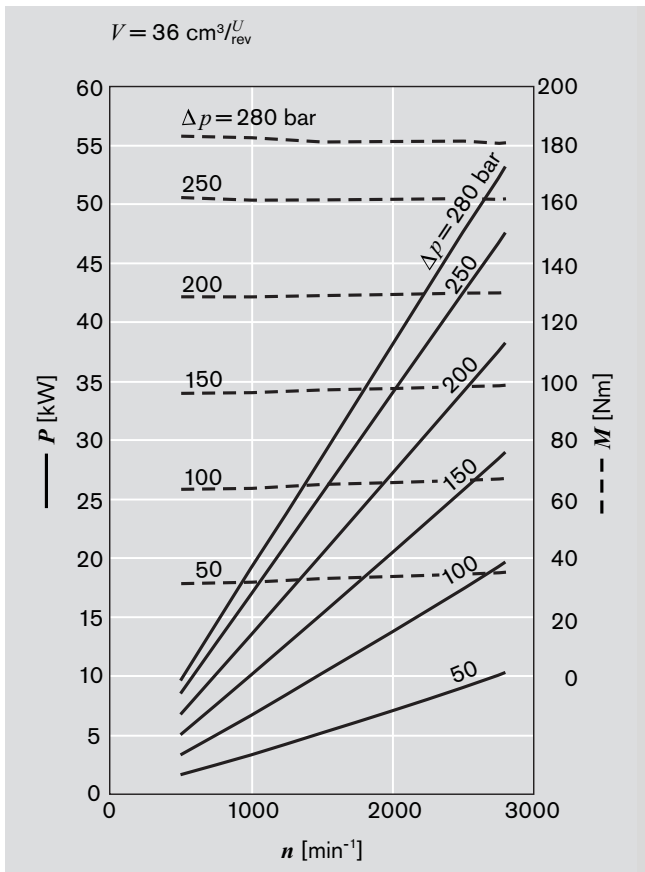
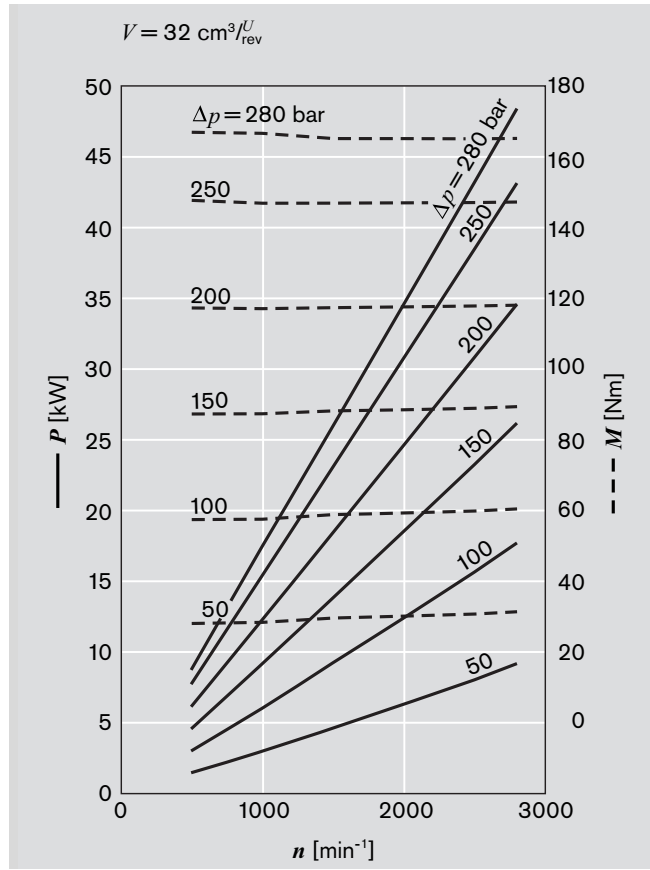
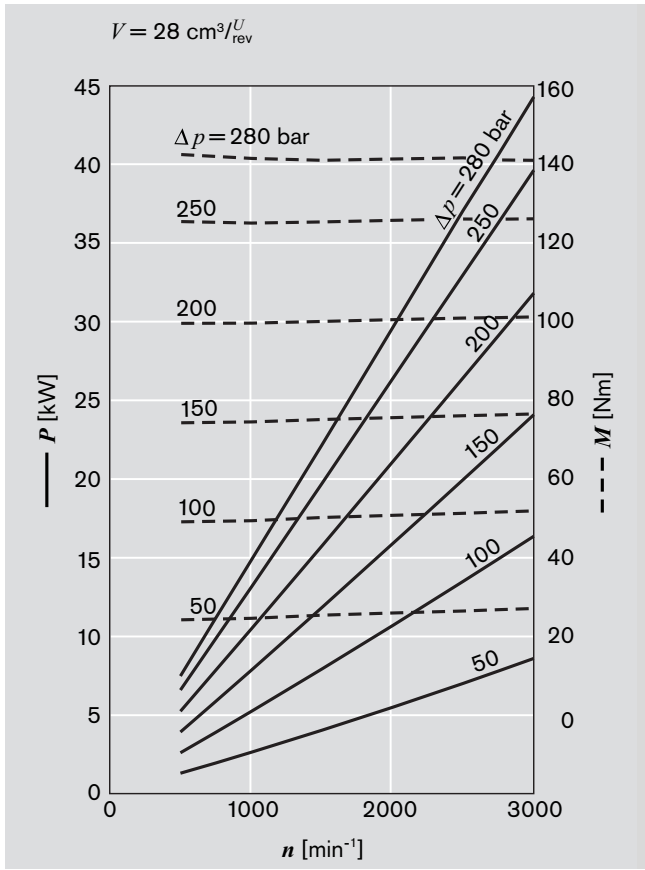

Performance charts (continued)

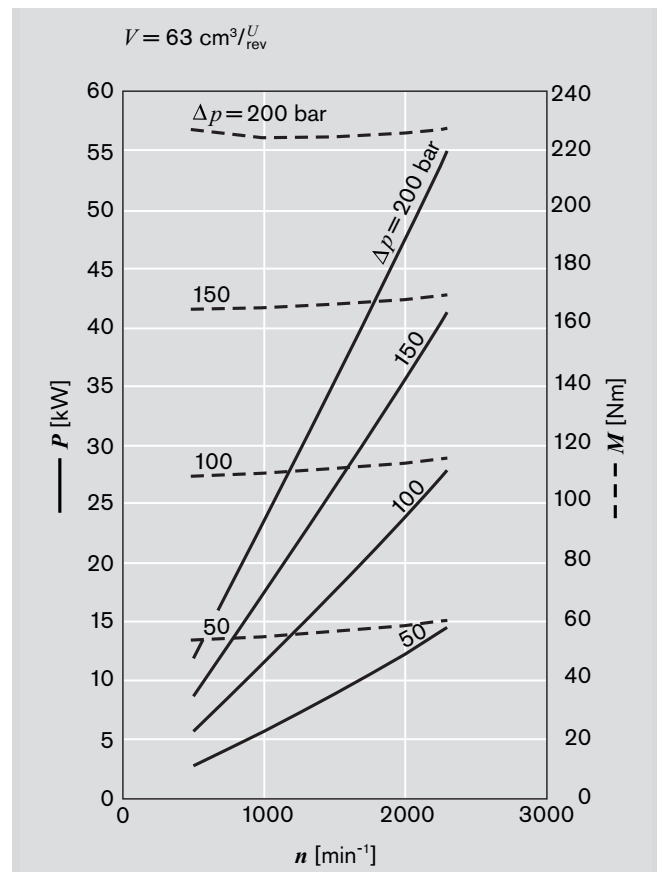
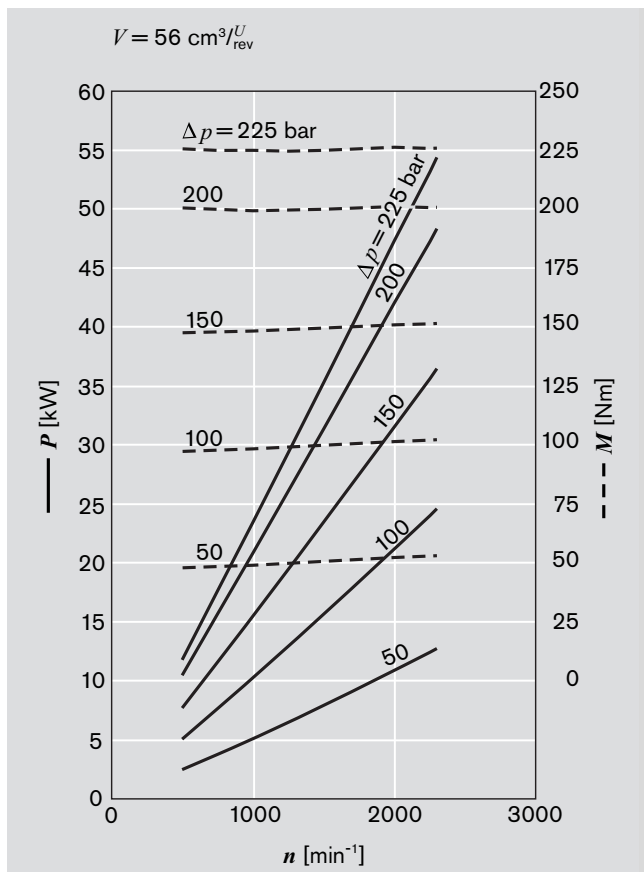
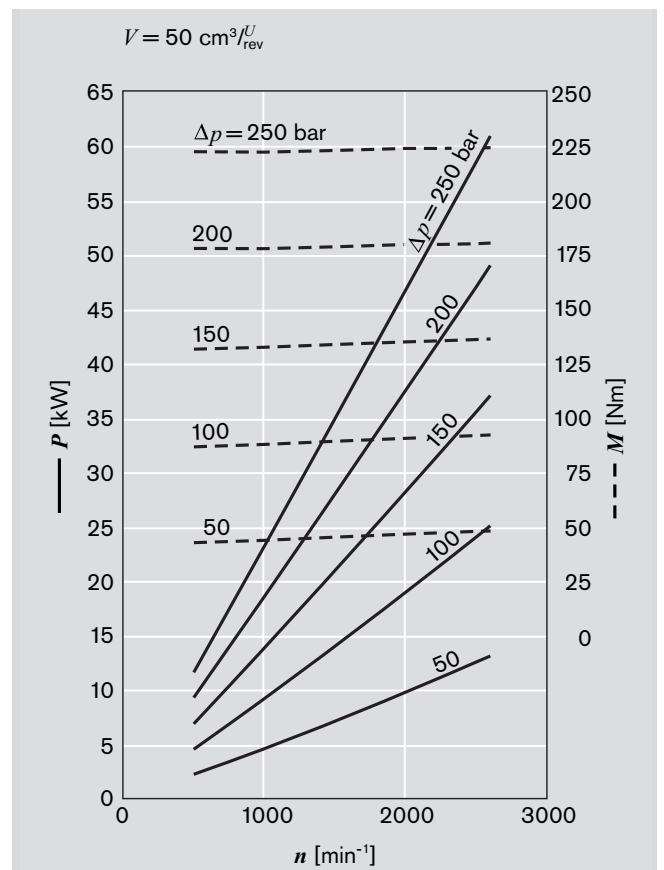
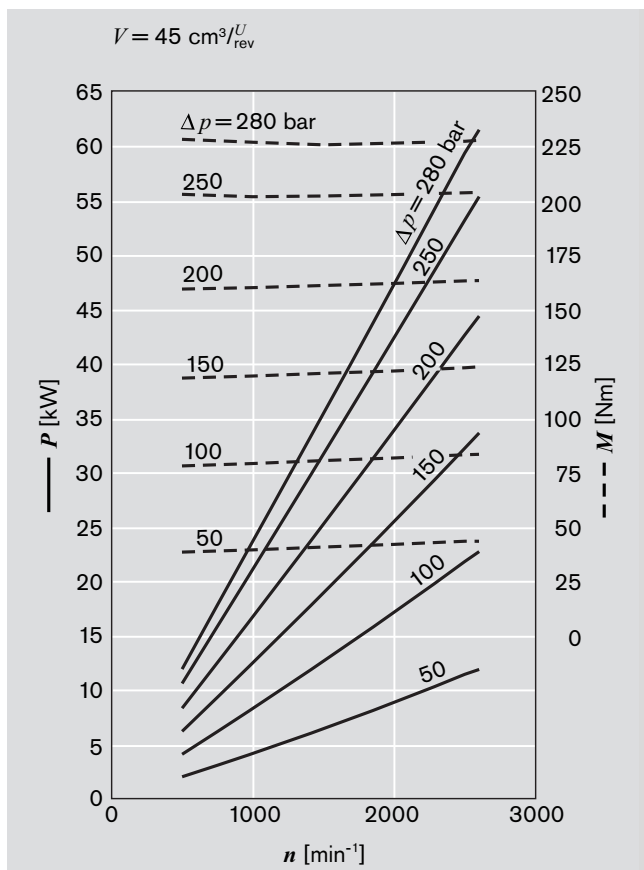

# Noise charts

**Noise level** dependent on rotational speed, pressure range between 10 bar and pressure value  $p_2$  (see page 14 Specifications table).

Oil data:  $\nu = 32 \text{ mm}^2/\text{s}$ ,  $\vartheta = 50^\circ\text{C}$ .

Sound pressure level calculated from noise measurements made in the sound absorbent measuring room compliant with DIN 45 635, Part 26.

Spacing between measuring sensor – pump: 1 m.

These are typical characteristic values for the respective model. They describe the airborne sound emitted solely by the pump. Environmental influences (installation site, piping, further system components) are not taken into consideration. Each value applies for a single pump.

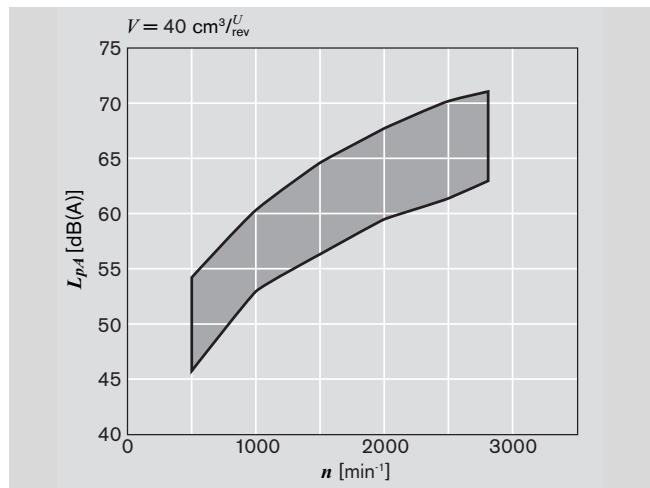
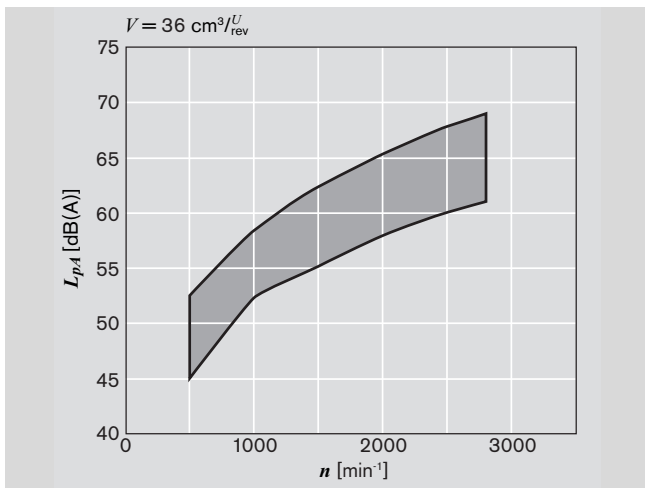
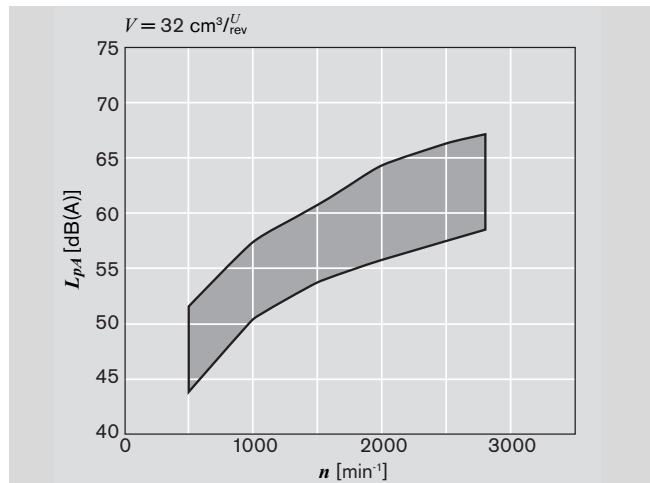
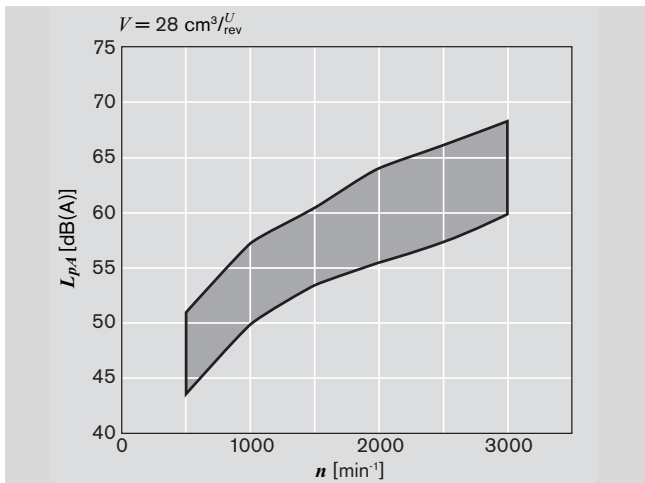
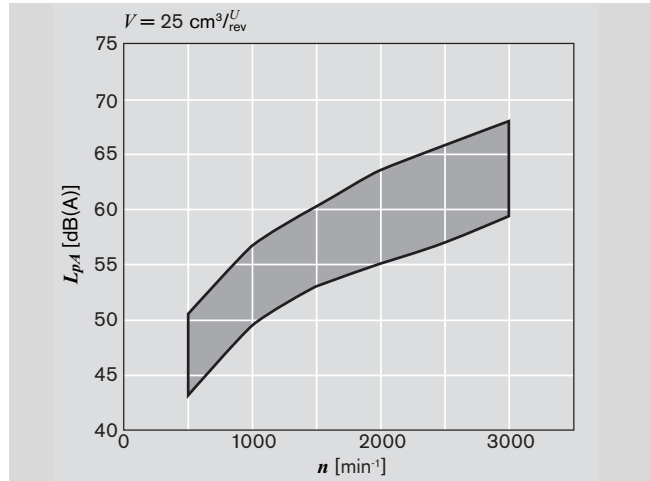
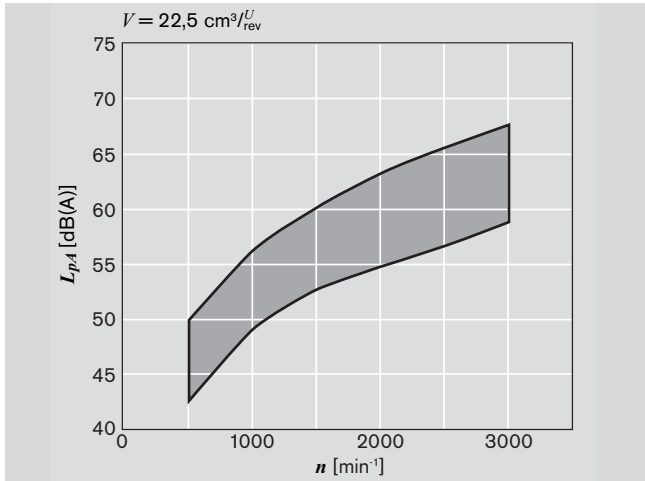

Noise charts (continued)

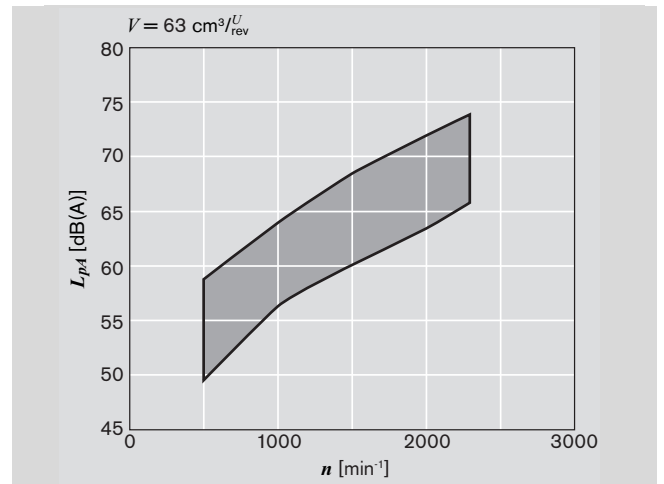
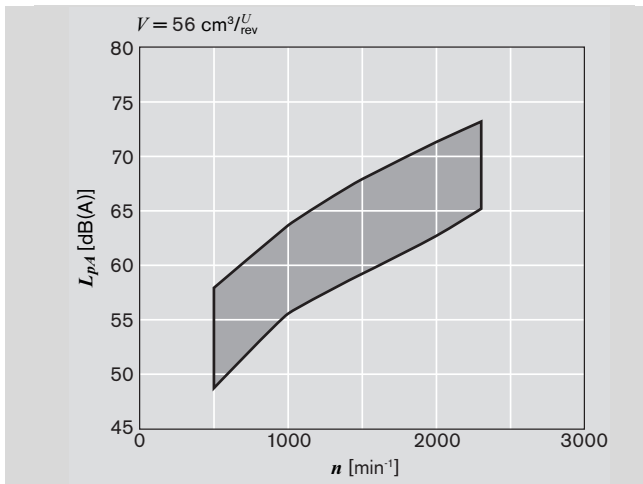
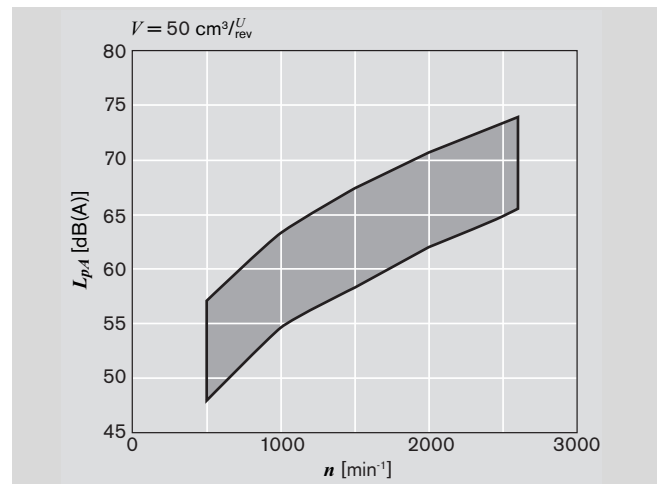
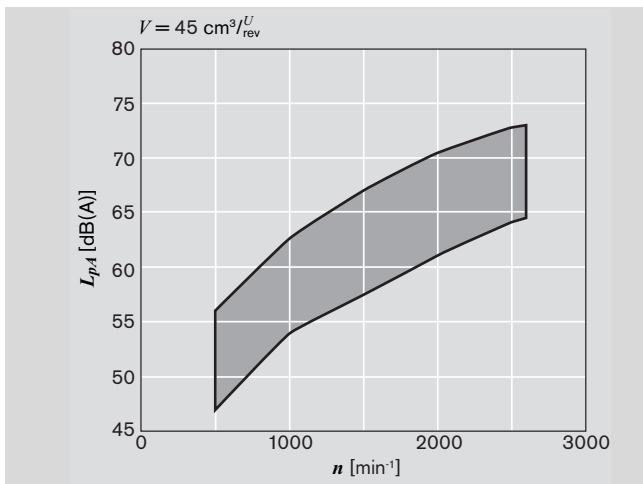

# Specification

General	
Construction	External gear pump
Mounting	Flange or through-bolting with spigot
Line ports	Flange
Direction of rotation (looking on shaft)	Clockwise or counter-clockwise, the pump may only be driven in the direction indicated
Installation position	Any
Load on shaft	Radial and axial forces after consulting
Ambient temperature range	-30°C...+80°C or max. +110°C with FKM seals
Hydraulic fluid	- Mineral oil compliant with DIN 51 524, 1-3, however under higher load at least HLP compliant with DIN 51 524 Part 2 recommended. - Comply with RE 90220 - Further operating fluids possible after consultation
Viscosity	12...800 mm <sup>2</sup> /s permitted range 20...100 mm <sup>2</sup> /s recommended range ...2000 mm <sup>2</sup> /s range permitted for starting
Hydraulic fluid temperature range	max. +80°C with NBR seals *) max. +110°C with FKM seals **)
Filtration ***)	At least cleanliness level 20/18/15 compliant with ISO 4406 (1999)

\*) NBR = Perbunan®  
 \*\*) FKM = Viton®  
 \*\*\*) On hydraulic systems or devices with critical counter-reaction, such as steering and counterbalance valves, the type of filtration selected must be adapted to the sensitivity of these devices/systems.

Safety requirements pertaining to the whole systems are to be observed.

In the case of applications with high numbers of load cycles please consulting.

## Definition of direction of rotation

Always look on the drive shaft.

**Caution:** Dimensions drawings always show clockwise-rotation pumps. On counterclockwise-rotation pumps the positions of the drive shaft and the suction and pressure ports are different.

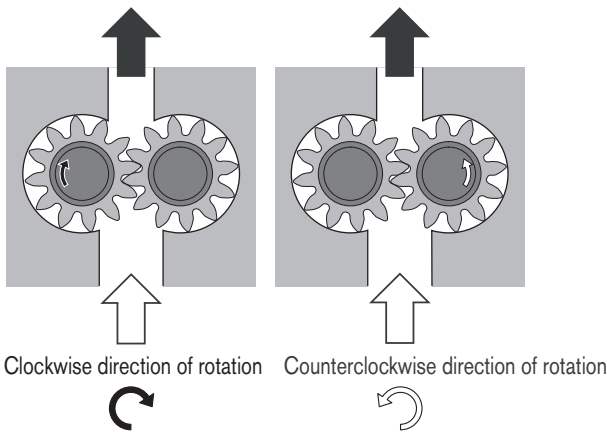

## Definitions of pressures

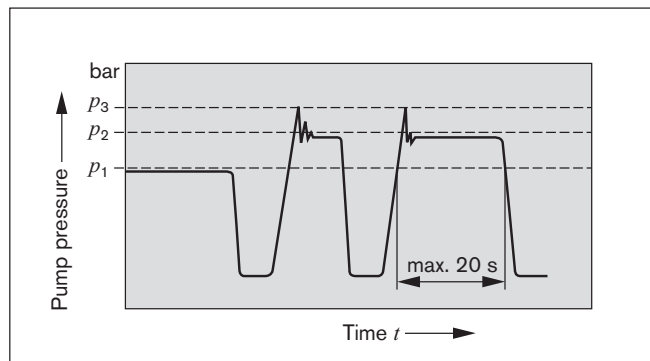

$p_1$  max. continuous pressure  
 $p_2$  max. intermittend pressure  
 $p_3$  max. peak pressure

## Size AZPU

Displacement	V	cm <sup>3</sup> /rev	22.5	25	28	32	36	40	45	50	56	63
Suction pressure	$p_e$		0,7...3 (absolute), with tandem pumps: $p_e (p_2) = \max. 0.5 > p_e (p_1)$									
max. continuous pressure	$p_1$	bar	250							220	195	170
max. intermittent pressure	$p_2$		280							250	225	200
max. peak pressure	$p_3$		300							280	250	230
min.	< 100	rpm	500	500	500	500	500	500	500	500	500	500
rpm at bar	12 mm <sup>2</sup> /s		1,200	1,200	1,000	1,000	1,000	800	800	800	800	800
	180... $p_2$		1,400	1,400	1,400	1,400	1,200	1,200	1,000	1,000	1,000	
	25 mm <sup>2</sup> /s	$p_2$	600	600	500	500	500	500	500	500	500	
max. rotational speed at	$p_2$		3,000	3,000	3,000	2,800	2,800	2,800	2,600	2,600	2,300	2,300

# Drive arrangement

## 1. Flexible couplings

The coupling must not transfer any radial or axial forces to the pump.

Refer to the fitting instructions provided by the coupling manufacturer for details of the maximum permitted shaft misalignment.

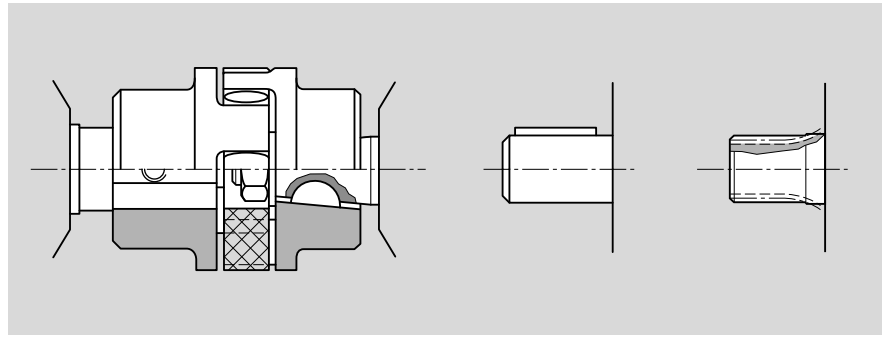

## 2. Coupling sleeve

Used on shafts with DIN or SAE splining. Caution: There must be no radial or axial forces exerted on the pump shaft or coupling sleeve. The coupling sleeve must be free to move axially. The distance between the pump shaft and drive shaft must be  $3.5^{+1.5}$ . Oil-bath or oil-mist lubrications is necessary.

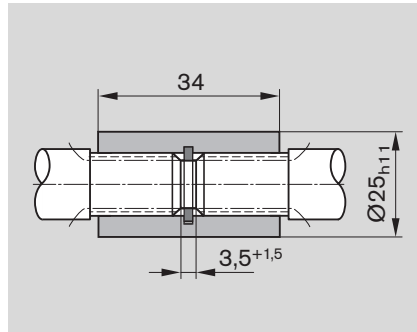

Splined shaft	Ordering code	$M_{max}$ [Nm]
SAE-B 13 teeth	D	300

## 3. Drive shaft with tang

For the close-coupling of the pumps to electric motor or internal-combustion engine, gear, etc. The pump shaft has a special tang and driver ③ (not included in supply).

There is no shaft sealing.

The recommended arrangements and dimensions for the drive end and sealing are as follows.

### ① Drive shaft

Case-hardening steel DIN 17 210  
 e.g. 20 MnCrS 5  
 case-hardened 1.0 deep; HRA 83 $\pm$ 2  
 Surface for sealing ring  
 ground without rifling  $R_t \leq 4\mu\text{m}$

### ② Radial shaft seal

with rubber covered seal  
 (see DIN 3760, Type AS, or double-lipped ring).  
 Cut 15° chamfer or fit shaft seal ring with protection sleeve.

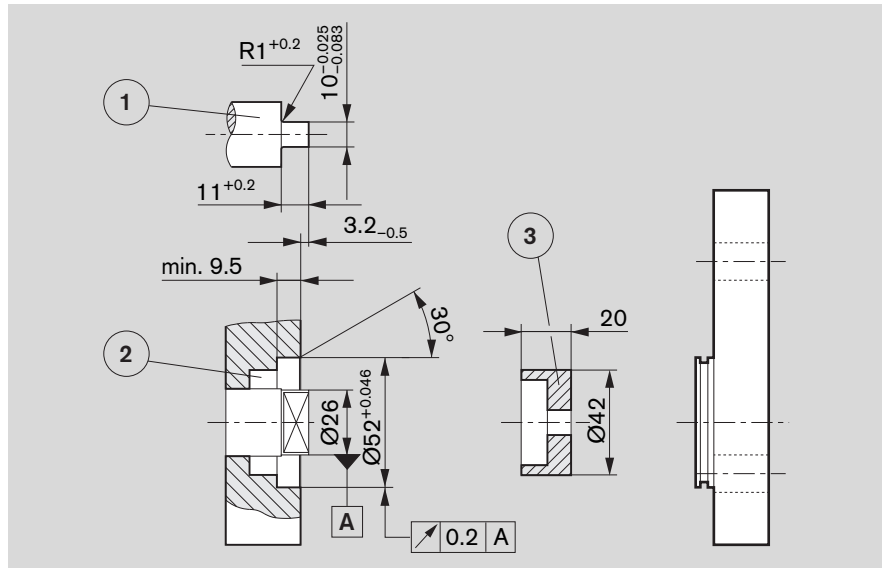

$M_{max}$ [Nm]	$V$ [cm <sup>3</sup> /rev]	$p_{max}$ [bar]
130	28	260
	36	200
	40	180
	45	160
	50	150
	56	130
	63	110
	70	100
	80	90
100	70	

**4. V-belts and straight gearwheels or helical toothed gear drives without outboard bearing**

When proposing to use V-belt or gear drive, please submit details of the application for our comments (especially dimensions  $a$ ,  $d_m$ ,  $d_w$  and angle  $\alpha$ ). For helical toothed gear drives, details of the helix angle  $\beta$  are also required.

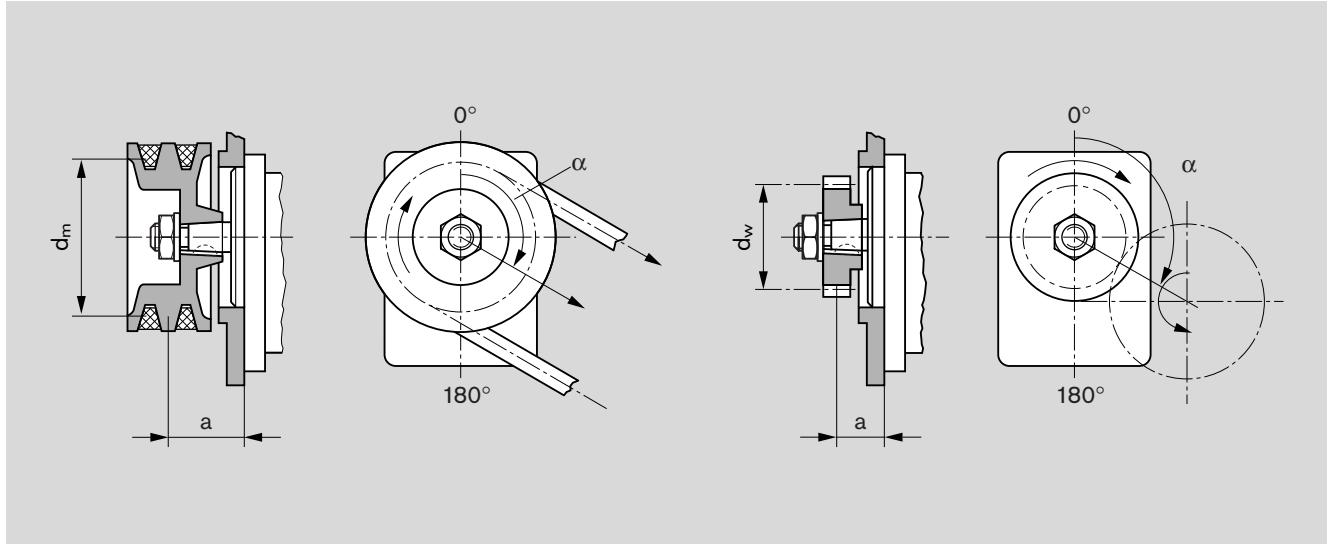

**5. Outboard bearing**

Outboard bearing eliminate possible problems when the pumps are driven by V-belts or gearwheels. The diagrams below show the maximum radial and axial loads that can be tolerated based on a bearing life of  $L_H = 1000$  h.

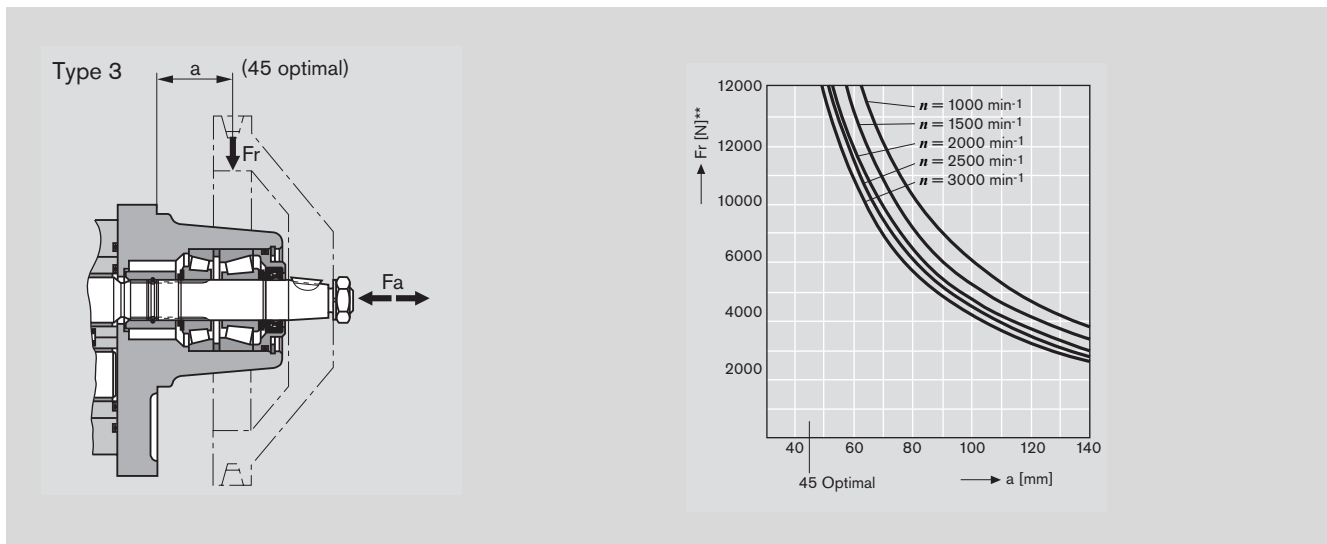



# Multiple gear pumps

Gear pumps are suitable for multiple setups, whereby the drive shaft for the 1st pump is extended to a second and even a 3rd pump. A coupling is fitted between each pair of pumps.

In most cases each pump is isolated from its neighbor, i.e. the suction ports are separate from one another. A common suction port is also possible as an option.

**Caution:** Basically, the specifications for the single pumps apply, but with certain restrictions:

**Max. speed:** This is determined by the highest rated pump speed in use.

**Pressures:** These are restricted by the strength of the drive shaft, the through drives and the drivers. Appropriate data is given in the dimensional drawings.

### Pressure restrictions during standard through drive

In the case of series U, the driver for the second pumping stage can carry a load of up to  $M_{max.} = 130 \text{ Nm}$ , i.e. there is a pressure restriction for the second stage and any further stages.

$M_{max.}$ [Nm]	$V$ [cm <sup>3</sup> /rev]	$p_{max}$ [bar]
65 Series F, S	16	230
	19	190
	22.5	160
	25	140
	28	130
130 Series G, U	22.5	280
	25	280
	28	260
	32	230
	36	200
	40	180
	45	160
	50	150
	56	130
	63	110

If the 1st stage is driven through a tang (driver) or outboard bearing type 1, pressure restrictions apply as indicated in the formula below.

Reinforced through drives are available for applications with higher transfer torques and/or rotational vibrations. Customized designs available on request.

### Reinforced through drive

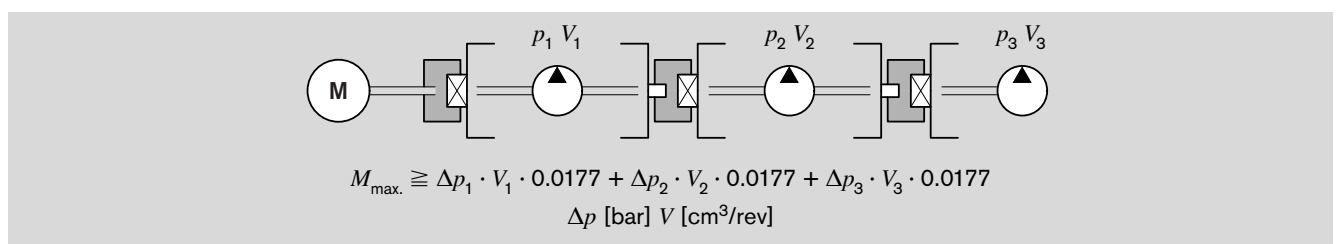
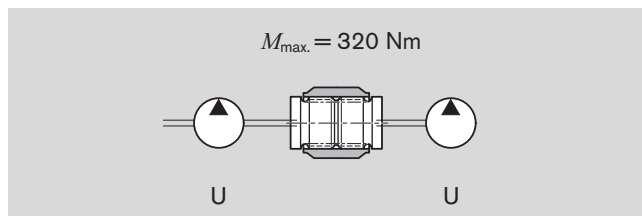

### Standard through drive

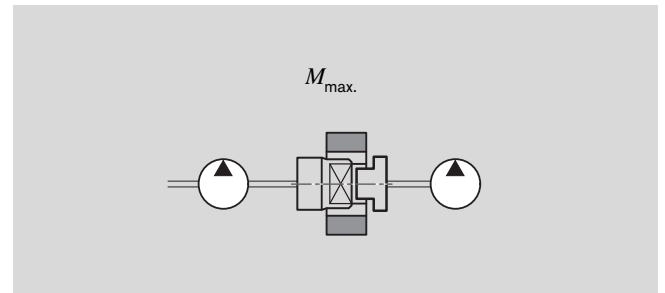

### Combinations

Series Pump 1	$M_{max.}$ [Nm]	Series Pump 2
U	130	G, U
U	65	F, S

For configuration of multiple pumps we recommend the pump is positioned with the largest displacement on the drive side.

### Max. transferrable drive torque

Function	Code	Designation	Max. transferrable drive torque * [Nm]
Splined shafts	D	SAE J744 22-4 (13T 16/32 DL)	300
	E	SAE-C 15 teeth	450
Tapered key shaft	C	1:5	290
	H	1:8	240

\* These figures are valid providing the conditions defined on pages 15 and 16 are observed. Bosch Rexroth is to be consulted if the stated values are exceeded.

# Dimensions

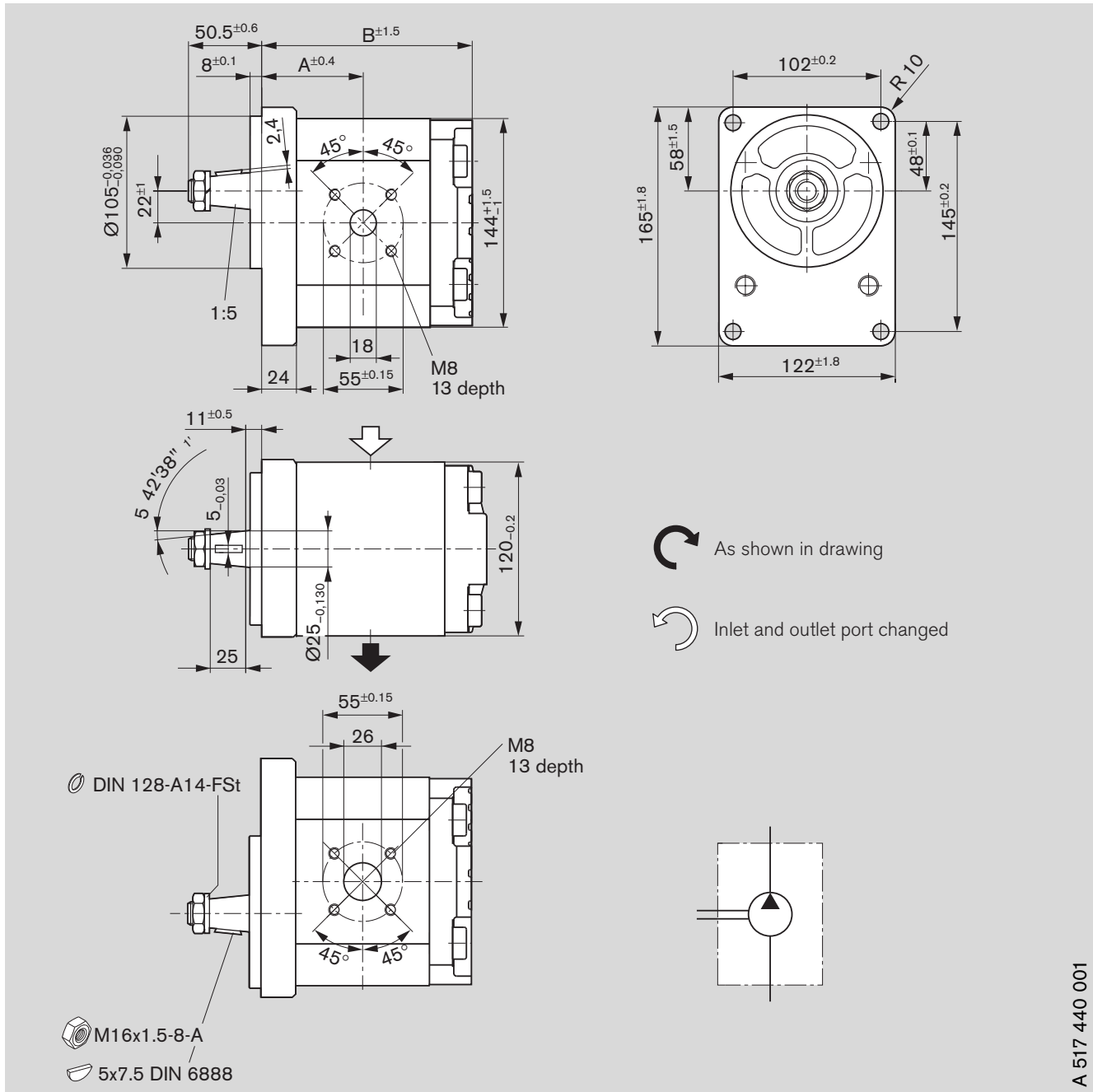

## Standard range



A 517 440 001

**Ordering code:**

AZPU - 22 -     C B 20 M B

Displacement [cm <sup>3</sup> /rev]	Ordering-No.		max. operating pressure [bar]	max. rotation speed [rpm]	Mass [kg]	Dimension [mm]	
	 L	 R				A	B
22.5	0 517 725 322	0 517 725 026	280	3,000	10.3	60.9	124.6
25	0 517 725 323	0 517 725 027	280	3,000	10.4	61.9	126.6
28	0 517 725 324	0 517 725 028	280	3,000	10.5	63.2	129.1
32	0 517 725 325	0 517 725 029	280	2,800	10.7	64.8	132.4
36	0 517 725 326	0 517 725 030	280	2,800	10.9	66.4	135.7
40	0 517 725 327	0 517 725 031	280	2,800	11.0	68.1	139.0
45	0 517 725 328	0 517 725 032	280	2,600	11.2	70.1	143.1
50	0 517 825 301	0 517 825 001	250	2,600	11.4	72.2	147.2
56	0 517 825 302	0 517 825 002	225	2,300	11.7	74.7	152.2
63	0 517 825 303	0 517 825 003	200	2,300	12.0	77.6	158.0

# Dimensions

## Standard range

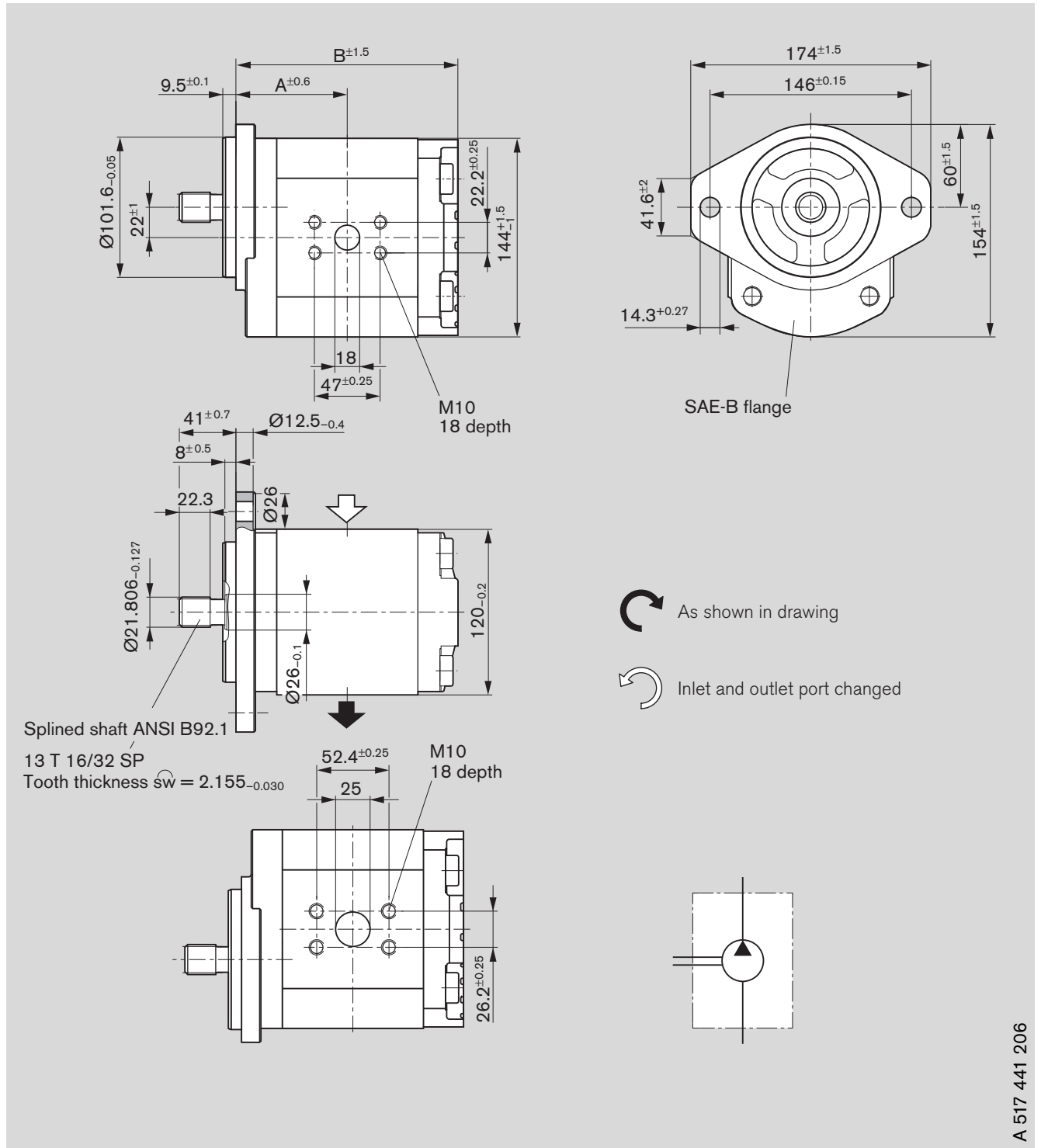

A 517 441 206

### Ordering code:

AZPU - 22 -     D C 07 K B

Displacement [cm <sup>3</sup> /rev]	Ordering-No.		max. operating pressure [bar]	max. rotation speed [rpm]	Mass [kg]	Dimension [mm]	
	L	R				A	B
22.5	0 517 725 329	0 517 725 033	280	3,000	9.6	66.4	130.1
25	0 517 725 330	0 517 725 034	280	3,000	9.7	67.4	132.1
28	0 517 725 331	0 517 725 035	280	3,000	9.8	68.7	134.6

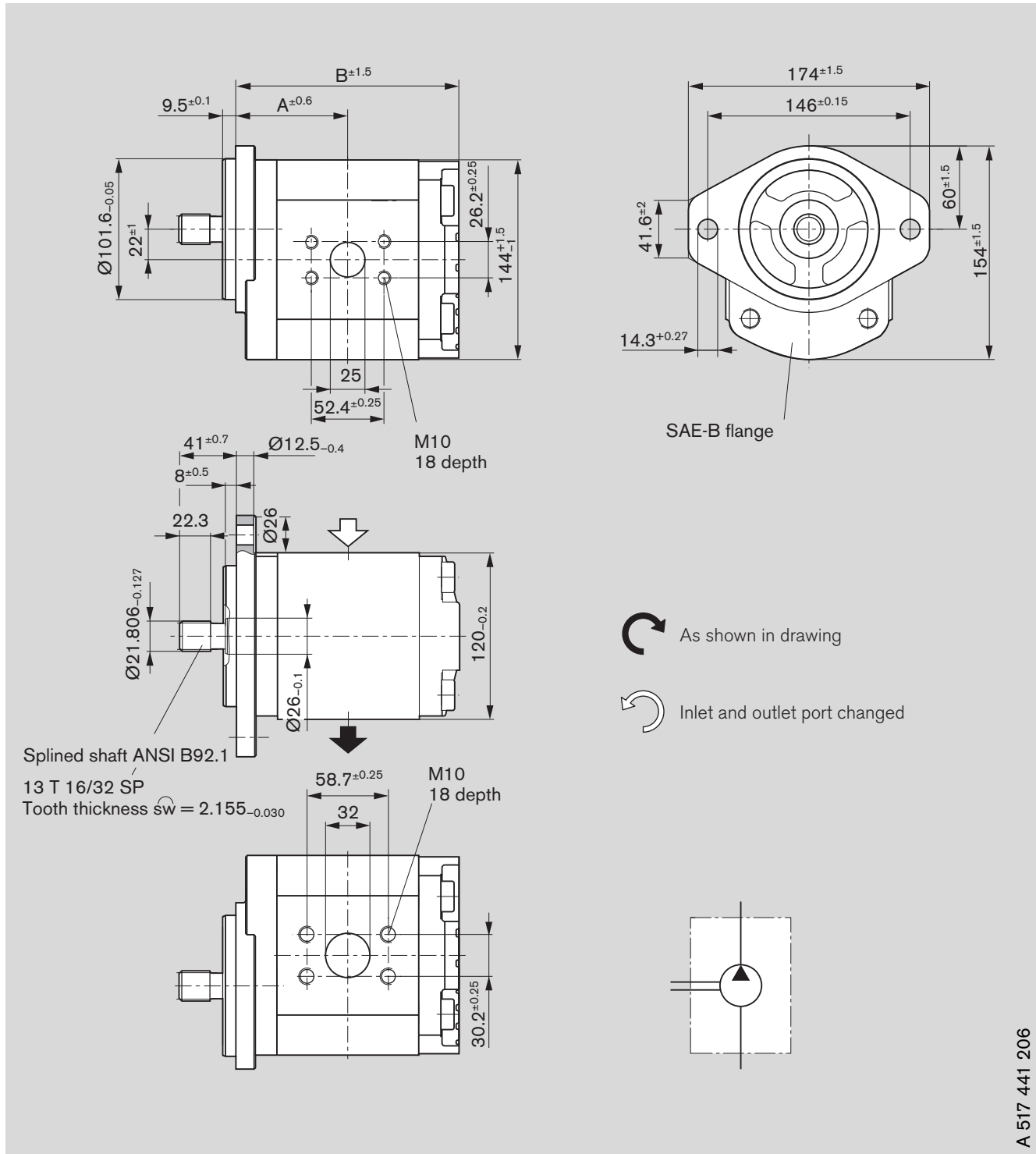

# Dimensions

## Standard range



**Ordering code:**

AZPU - 22 -     DC 07 K B

Displacement [cm <sup>3</sup> /rev]	Ordering-No.		max. operating pressure [bar]	max. rotation speed [rpm]	Mass [kg]	Dimension [mm]	
	 L	 R				A	B
32	0 517 725 332	0 517 725 036	280	2,800	10.0	70.3	137.9
36	0 517 725 333	0 517 725 037	280	2,800	10.1	71.9	141.2
40	0 517 725 334	0 517 725 038	280	2,800	10.3	73.6	144.5
45	0 517 725 335	0 517 725 039	280	2,600	10.5	75.6	148.6
50	0 517 825 304	0 517 825 004	250	2,600	10.7	77.7	152.7

# Dimensions

## Standard range

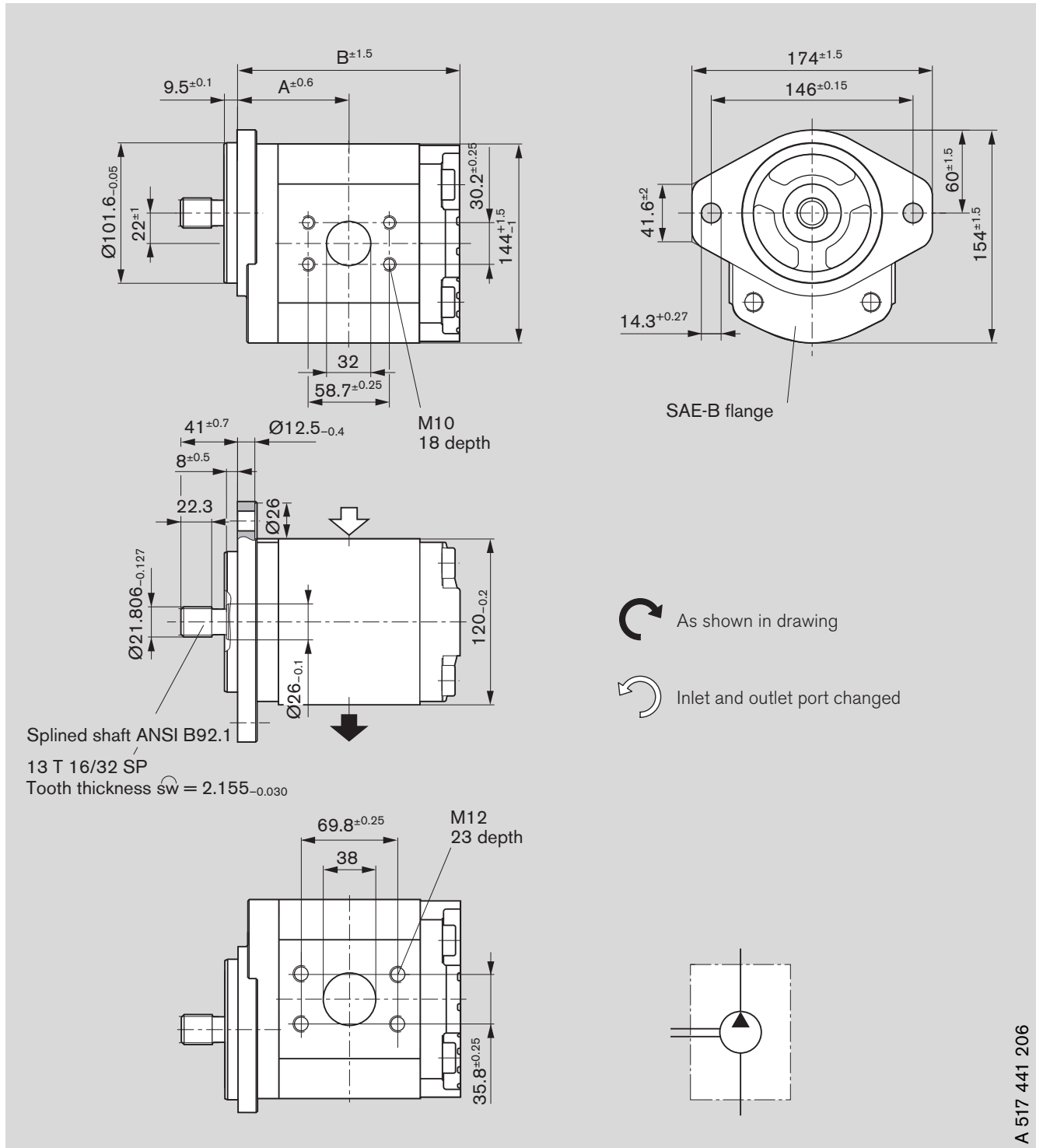

A 517 441 206

**Ordering code:**

AZPU - 22 -     D C 07 K B

Displacement [cm <sup>3</sup> /rev]	Ordering-No.		max. operating pressure [bar]	max. rotation speed [rpm]	Mass [kg]	Dimension [mm]	
	L	R				A	B
56	0 517 825 305	0 517 825 005	225	2,300	11.0	80.2	157.7
63	0 517 825 306	0 517 825 006	200	2,300	11.3	83.1	163.5

# Fittings

Fittings can be used for rectangular flange **20** see page 7

Gear pump flange, 90° angle

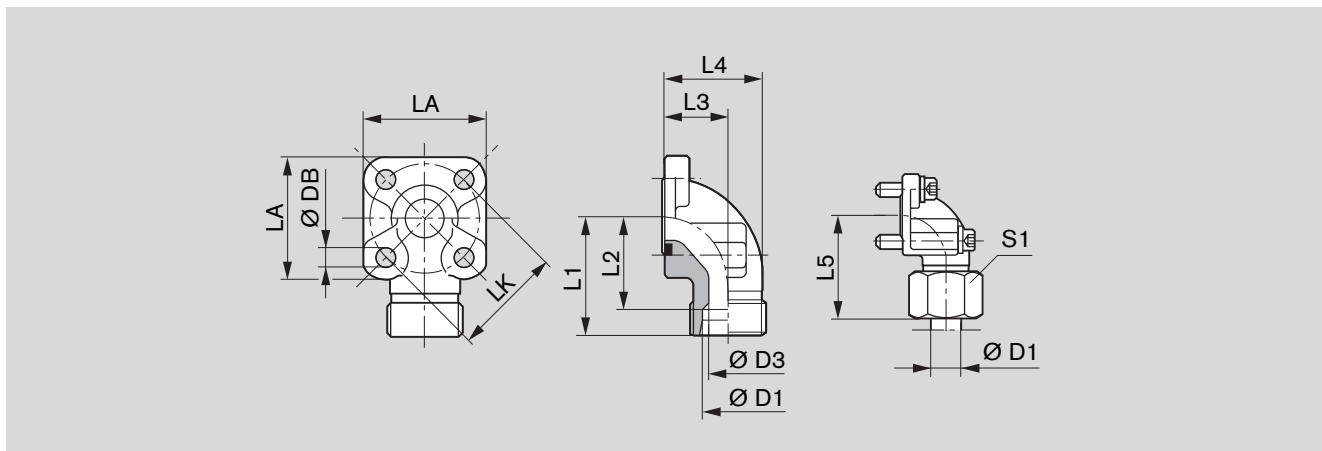

LK	D1	D3	L1	L2	L3	L4	L5	LA	S1	DB	Screws 2 pcs.	2 pcs.	Seal ring	Mass kg	Part number	<i>p</i> (bar)
55	20S	17	45	34.5	24.0	40.0	56.0	58	36	8.4	M8x25	M8x50	33x2.5	0.44	<b>1 515 702 004</b>	250
55	30S	26	49	35.5	32.0	50.0	62.0	58	50	8.4	M8x25	M8x50	33x2.5	0.50	<b>1 515 702 006</b>	250
55	35L	31	49	38.5	32.0	51.5	62.0	58	50	8.4	M8x25	M8x60	32x2.5	0.47	<b>1 515 702 005</b>	100
55	42 L	38	49	38.0	40.0	64.5	61.0	58	60	8.4	M8x25	M8x70	32x2.5	0.60	<b>1 515 702 019</b>	100

Complete fittings with seal ring, metric screw set, nuts and olive.

## Note

The permissible tightening torques can be found in our publication:

“General operating instructions for external gear units”

RE 07 012-B1.

# Notes for commissioning

## Filter recommendation

The major share of premature failures in external gear pumps is caused by contaminated hydraulic fluid.

As a warranty cannot be issued for dirt-specific wear, we recommend filtration compliant with cleanliness level 20/18/15 ISO 4406, which reduces the degree of contamination to a permissible dimension in terms of the size and concentration of dirt particles:

Operating pressure [bar ]	>160	<160
Contamination class ISO 4406	18/15	19/16
To be reached with $\beta_x = 75$	20	25

We recommend that a full-flow filter always be used. Basic contamination of the hydraulic fluid used may not exceed class 20/18/15 according to ISO 4406. Experience has shown that new fluid quite often lies above this value. In such instances a filling device with special filter should be used.

## General

- The pumps supplied by us have been checked for function and performance. No modifications of any kind may be made to the pumps; any such changes will render the warranty null and void!
- Pump may only be operated in compliance with permitted data (see pages 15 – 18).

## Project planning notes

Comprehensive notes and suggestions are available in Hydraulics Trainer, Volume 3 RE 00 281, "Project planning notes and design of hydraulic systems". Where external gear pumps are used we recommend that the following note be adhered to.

## Technical data

All stated technical data is dependent on production tolerances and is valid for specific marginal conditions.

Note that, as a consequence, scattering is possible, and at certain marginal conditions (e.g. viscosity) **the technical data may change.**

## Characteristics

When designing the external gear pump, note the maximum possible service data based on the characteristics displayed on pages 10 to 12.

Additional information on the proper handling of hydraulic products from Bosch Rexroth is available in our document: "General product information for hydraulic products" RE 07 008.

## Contained in delivery

The components with characteristics as described under ordering code and device measurements, pages 18 – 21, are contained in delivery.

**You can find further information in our publication: "General Operating Instructions for External Gear Units" RE 07 012-B1.**

# Service parts

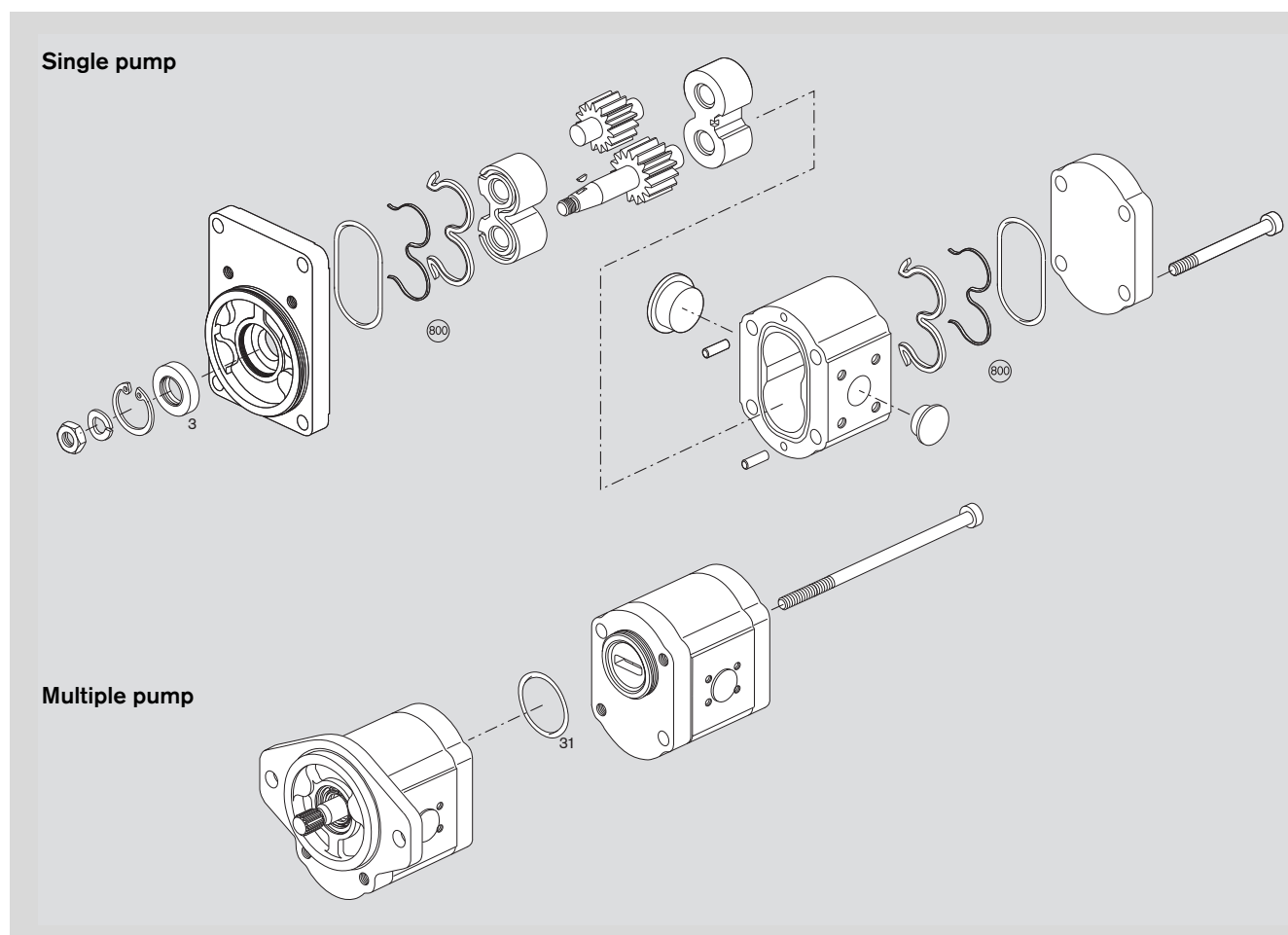

Page	Ordering code	Seal kit "U" Item 800 NBR	Shaft seal ring Item 3	Dimension	Material
18	AZPU - 22 - □□□ □ C B 20 M B	1 517 010 231	1 510 283 072	42 x 26 x 7	NBR
19, 20, 21	AZPU - 22 - □□□ □ D C 07 K B	1 517 010 231	1 510 283 069	42 x 26 x 7	FKM

NBR = Perbunan® FKM = Viton®

For multiple pumps	Seal ring Item 31 NBR	1 900 210 145



## The AZ configurator at [www.boschrexroth.com/azconfigurator](http://www.boschrexroth.com/azconfigurator)

The AZ configurator assists you to configure your individual external gear unit easily and user-friendly. You only need to specify your requirements: From the displacement, direction of rotation, drive shaft, connection flange right up to the required rear cover. You immediately receive a project drawing (PDF format) if a configuration already exists. You receive the price of the configured external gear unit upon request.



The AZ configurator assists you to configure your individual external gear unit easily and user-friendly – all data needed for project planning are acquired thru menu guidance.

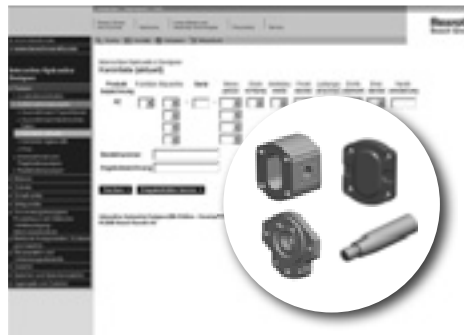

Selection is made either on an ordering code or your technical requirements. This means that you can search for external gear units that have already been configured, or you specify the configuration variant of the external gear unit based upon the operating parameters you require.



If the external gear unit you selected has been released you will receive the part number, ordering code and a detailed installation drawing. If your special configuration is not available please send your specification to Rexroth. One of our employees will then contact you.

# Ordering-No.

Ordering-No.	Page	Ordering-No.	Page	Ordering-No.	Page
0 517 725 004	20	0 517 725 039	20	0 517 725 334	20
0 517 725 026	18	0 517 725 304	20	0 517 725 335	20
0 517 725 027	18	0 517 725 322	18	0 517 825 001	18
0 517 725 028	18	0 517 725 323	18	0 517 825 002	18
0 517 725 029	18	0 517 725 324	18	0 517 825 003	18
0 517 725 030	18	0 517 725 325	18	0 517 825 005	21
0 517 725 031	18	0 517 725 326	18	0 517 825 006	21
0 517 725 032	18	0 517 725 327	18	0 517 825 301	18
0 517 725 033	19	0 517 725 328	18	0 517 825 302	18
0 517 725 034	19	0 517 725 329	19	0 517 825 303	18
0 517 725 035	19	0 517 725 330	19	0 517 825 305	21
0 517 725 036	20	0 517 725 331	19	0 517 825 306	21
0 517 725 037	20	0 517 725 332	20		
0 517 725 038	20	0 517 725 333	20		

Bosch Rexroth AG  
 External Gear Units  
 Robert-Bosch-Straße 2  
 D-71701 Schwieberdingen  
 Telefon +49 (0) 711-811 10 63  
 Telefax +49 (0) 711-811 17 98  
 brm-az.info@boschrexroth.de  
 www.boschrexroth.com/brm

© This document, as well as the data, specifications and other information set forth in it, are the exclusive property of Bosch Rexroth AG. It may not be reproduced or given to third parties without its consent.

The data specified above only serve to describe the product. No statements concerning a certain condition or suitability for a certain application can be derived from our information. The information given does not release the user from the obligation of own judgment and verification. It must be remembered that our products are subject to a natural process of wear and aging.



Bosch Rexroth AG  
External Gear Units  
Robert-Bosch-Straße 2  
D-71701 Schwieberdingen  
Telefon +49 (0) 711-811 10 63  
Telefax +49 (0) 711-811 17 98  
brm-az.info@boschrexroth.de  
www.boschrexroth.com/brm

© This document, as well as the data, specifications and other information set forth in it, are the exclusive property of Bosch Rexroth AG. It may not be reproduced or given to third parties without its consent. The data specified above only serve to describe the product. No statements concerning a certain condition or suitability for a certain application can be derived from our information. The information given does not release the user from the obligation of own judgment and verification. It must be remembered that our products are subject to a natural process of wear and aging.